

# Inox Care



**Edelstahl, matt**

acier inoxydable, mat

Acciaio inossidabile, opaco

**Qualitätsmerkmale****Material**

- Edelstahl 1.4301
- Rohrdurchmesser 32 mm
- Materialstärken 1.65 mm

**Masse**

- Wandabstand – Achse Rohr 64 mm
- Abdeckrosette D = 70 mm
- Montageflansch D = 60 mm

Alle Masse sind Achse – Achse gemessen (Ausnahme, die Duschhandläufe sind Achse – Wand gemessen)

→ Unsere Masszeichnungen finden Sie unter [www.nosag.ch/download](http://www.nosag.ch/download)

Für Spezialanfertigungen bitte die Vorlagen für Massangaben auf unserer Internetseite benutzen.

**Montage**

- Bohrschablonen auf Anfrage erhältlich
- Alle Produkte werden mit verdeckter Montage geliefert
- Für alle klappbaren Produkte und die Stützgriffe muss das Montagmaterial entsprechend des Mauerwerks bestellt werden. Bei den restlichen Produkten wird das Montagmaterial mitgeliefert.

Alle abgebildeten Winkelgriffe und Duschhandläufe sind immer aus Sicht des Monteurs in der Ausführung links.

**Signes de qualité****Matériaux**

- acier inoxydable 1.4301
- diamètre 32 mm
- épaisseur du matériau 1.65 mm

**Mesures**

- distance du mur au tube 64 mm
- rosace D = 70 mm
- rosace perforée D = 60 mm

Toutes les dimensions sont mesurées d'axe en axe des tubes (exception: les barres d'appui d'angle sont mesurées axe-mur)

→ Vous trouvez nos plans sous [www.nosag.ch/download](http://www.nosag.ch/download)

Pour toutes demandes de barre sur mesure, veuillez remplir le formulaire mis à disposition sur notre site

**Montage**

- Chablon de perçage sur demande.
- Tous les produits sont livrés avec montage invisible
- Pour les produits rabattables et barre d'appui mural les fixation au mur sont à définir suivant la nature du support. Pour les autres produits, le matériel de montage est fourni.

Toutes les images des barres d'appui d'angle sont des exécutions gauches du point de vue du monteur.

**Caratteristiche qualitative****Materiale**

- acier inoxydable 1.4301
- diamètre 32 mm
- épaisseur du matériau 1.65 mm

**Misure**

- Acciaio inossidabile 64 mm
- Diametro tubolare D = 70 mm
- Spessori del materiale D = 60 mm

Tutte le misure sono calcolate da asse ad asse (eccezione, i maniglioni per doccia sono misurati da asse a parete)

→ I nostri disegni tecnici quotati sono disponibili sul sito [www.nosag.ch/download](http://www.nosag.ch/download)

Per realizzazioni su ordinazione utilizzare i modelli per l'indicazione delle misure disponibili sul nostro sito Internet

**Montaggio**

- Su richiesta sono disponibili dime per la foratura
- Tutti i prodotti vengono forniti con elementi di montaggio nascosti
- Per tutti i prodotti ribaltabili e le impugnature di supporto il materiale per il montaggio deve essere ordinato in base al tipo di muratura. Per i prodotti restanti il materiale di fissaggio è incluso.

Tutti maniglioni angolari e i maniglioni per doccia sono raffigurati nella versione sinistra dal punto di vista dell'installatore



**Haltegriff** Edelstahl, matt gebürstet

**Barre d'appui** Acier inoxydable, mat

**Corrimano** Acciaio inossidabile, opaco

Max. 175 kg

NOSAG	SGVSB Team	Sanitas Troesch	A	B	C
NXW0.1003.583		4722 501	300		80
NXW0.1004.583		4722 502	400		80
NXW0.1006.583		4722 504	600		80
NXW0.1008.583		4722 506	800		80
NXW0.1010.583		4722 508	1000		80
NXW0.1011.583			1100		80

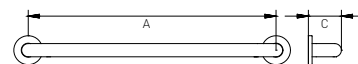

**Winkelgriff** Edelstahl, matt gebürstet

**Poignée de sécurité** Acier inoxydable, mat

**Corrimano ad angolo** Acciaio inossidabile, opaco

Max. 175 kg

NOSAG	SGVSB Team	Sanitas Troesch	A	B	C
NXW1.1033.583		4722 520	300	300	80
NXW1.1044.583			400	400	80





Abbildung in linker Ausführung (.L)  
Image execution gauche (.L)  
Immagine versione sinistra (.L)

**Winkelgriff** Edelstahl, matt gebürstet

**Poignée de sécurité** Acier inoxydable, mat

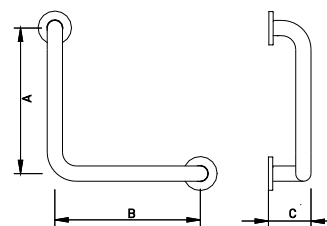
**Corrimano ad angolo** Acciaio inossidabile, opaco

**Max. 125 kg**

NOSAG	SGVSB Team	Sanitas Troesch	A	B	C
NXW1.1047.583.L		4722 523	750	400	
NXW1.1047.583.R		4722 524	750	400	
NXW1.1057.583.L			750	500	
NXW1.1057.583.R			750	500	
NXW1.1059.583.L		4722 525	950	500	
NXW1.1059.583.R		4722 526	950 <td 500		

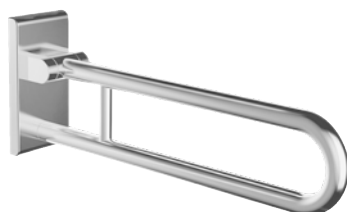
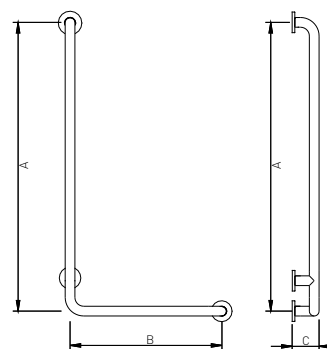

**Stützklappgriff** Edelstahl, matt gebürstet, mit Fallsicherung, **MIT Montageplatte**

**Barre d'appui rabattable** Acier inoxydable, mat, avec frein de sécurité, **AVEC plaque de montage**

**Corrimano ribaltabile** Acciaio inossidabile, opaco, con freno di sicurezza, **CON placca di montaggio**

**Max. 125 kg**

NOSAG	SGVSB Team	Sanitas Troesch	A	B	C
NXW2.1026.583		4722 561	600	226	110
NXW2.1027.583		4722 562	725	226	110
NXW2.1028.583		4722 563	850	226	110

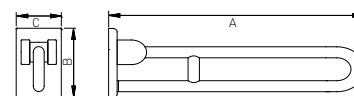

**Montagesets | Sets de montage | Set di montaggio**



für   pour   per	NOSAG	SGVSB Team	Sanitas Troesch
<b>Lochziegelsteine</b> Brique Mattone forato	NM1.0106.000	585 580	4721 795
<b>Vorwandssysteme</b> Murs préfabriqués Muri prefabbricati	NM1.0206.000	585 581	4721 796
<b>Beton</b> Béton Calcestruzzo	NM1.0306.000	585 599	4721 798



**Rückenstütze** Edelstahl, matt gebürstet, mit Rückenkissen schwarz

**Dossier** Acier inoxydable, mat, avec rembourrage noir

**Schienale** Acciaio inossidabile, opaco, schienale imbottito nero

NOSAG	SGVSB Team	Sanitas Troesch	A	B	C
NXWA.1410.583		4722 585	545	402	215
NXWA.1013.583			110	226	23

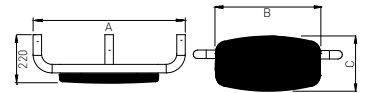

**Montagesets** | Sets de montage | Set di montaggio

für | pour | per

**Lochziegelsteine**

Brique

Mattone forato

**Vorwandssysteme**

Murs préfabriqués

Muri prefabbricati

**Beton**

Béton

Calcestruzzo

**NOSAG**

NM1.0106.000

**SGVSB Team**

585 580

**Sanitas Troesch**

4721 795

NM1.0206.000

585 581

4721 796

NM1.0306.000

585 599

4721 798

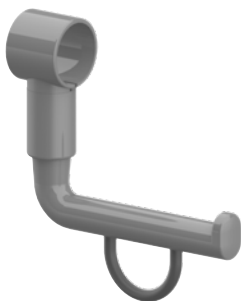

**Papierrollenhalter** Nylon, dunkelgrau, mit Abrollbremse

**Porte-rouleau** Nylon, gris foncé, avec système de freinage

**Portacarta** Nylon, grigio scuro, freno

**NOSAG**

NXWA.4132.337

**SGVSB Team**

4722 569

**Sanitas Troesch**

4721 798

**A**

120

**B**

143

**C**

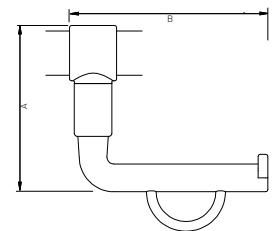



**Papierrollenhalter** Edelstahl, matt gebürstet

**Porte-rouleau** Acier inoxydable, mat

**Portacarta** Acciaio inossidabile, opaco

NOSAG	SGVSB Team	Sanitas Troesch	A	B	C
NXWA.1101.583		4722 661	171	82	

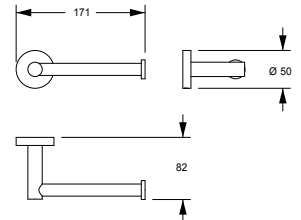

**Ersatzrollenhalter** Edelstahl, matt gebürstet, für 1 Rolle

**Porte-rouleau de réserve** Acier inoxydable, mat, pour 1 rouleau

**Portacarta di riserva** Acciaio inossidabile, opaco, per 1 rotolo

NOSAG	SGVSB Team	Sanitas Troesch	A	B	C
NXWA.1201.583		4722 663	171	82	

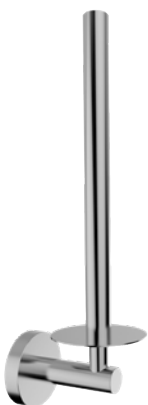
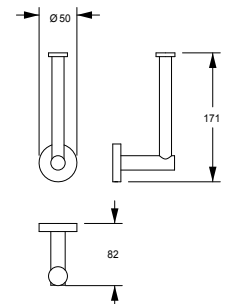

**Ersatzrollenhalter** Edelstahl, matt gebürstet, für 2 Rollen

**Porte-rouleau de réserve** Acier inoxydable, mat, pour 2 rouleaux

**Portacarta di riserva** Acciaio inossidabile, opaco, per 2 rotoli

Max. 125 kg

NOSAG	SGVSB Team	Sanitas Troesch	A	B	C
NXWA.1202.583			240	101	

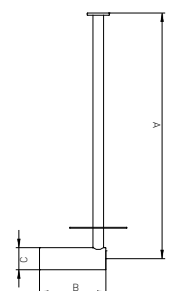



**Bürstengarnitur** Edelstahl, matt gebürstet, mit austauschbarem schwarzen Bürstenkopf Ø 86mm, zur Wandmontage

**Ensemble brosse** Acier inoxydable, mat, avec tête de brosse noire interchangeable Ø 86mm, pour montage mural

**Portaspazzola** Acciaio inox, spazzolato opaco, con testina nera sostituibile Ø 86 mm, per montaggio a parete

**Max. 175 kg**

NOSAG	SGVSB Team	Sanitas Troesch	A	B	C
NXWA.1302.583			499	102	135

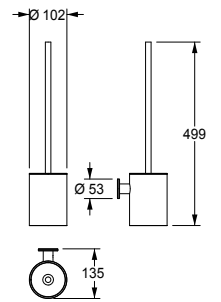

**Hygienebeutelspender** Edelstahl, matt gebürstet

**Distributeur de sachets hygiéniques** Acier inoxydable, mat

**Distributore sacchi igienici** Acciaio inossidabile, opaco

**Max. 175 kg**

NOSAG	SGVSB Team	Sanitas Troesch	A	B	C
NXWA.1500.583			95	136	27

**Dazugehöriger Artikel** | Article correspondant | Articoli correlati

**Hygienebeutel (30 Stk.)**

MWV.TAA901.000

Sachets hygiéniques (30 pcs.)

Sacchetti igienici (30 pz.)

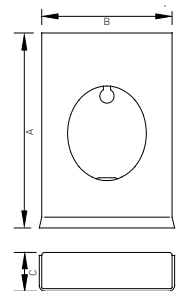



**Piktogramm | Pictogramme | Pittogramma**



**Männliche Person** Edelstahl, matt gebürstet

**Personnage masculin** Acier inoxydable, brossé mat

**Uomo** Acciaio inossidabile, spazzolato opaco

NOSAG	SGVSB Team	Sanitas Troesch	A	B	C
NWA.1710.583		4721 691	125	125	



**Weibliche Person** Edelstahl, matt gebürstet

**Personnage féminin** Acier inoxydable, brossé mat

**Donna** Acciaio inossidabile, spazzolato opaco

NOSAG	SGVSB Team	Sanitas Troesch	A	B	C
NWA.1711.583		4721 692	125	125	



**IV-WC** Edelstahl, matt gebürstet

**WC accessible** Acier inoxydable, brossé mat

**WC accessibile** Acciaio inossidabile, spazzolato opaco

NOSAG	SGVSB Team	Sanitas Troesch	A	B	C
NWA.1712.583		4721 693	125	125	



**Brausestange** Edelstahl, matt gebürstet, mit Brausehalter Nylon, dunkelgrau

**Glissières de douche** Acier inoxydable, mat, avec support à rotule nylon, gris foncé

**Asta per doccia** Acciaio inossidabile, opaco, con supporto doccia Nylon, grigio scuro

NOSAG	SGVSB Team	Sanitas Troesch	A	B	C
NXD0.1011.583		4722 533	1100		80

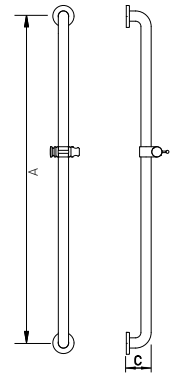

**Winkelgriff mit Brausestange** Edelstahl, matt gebürstet, mit Brausehalter Nylon, dunkelgrau

**Barre d'appui avec glissières de douche** Acier inoxydable, mat, avec support à rotule nylon, gris foncé

**Corrimano ad angolo con asta doccia** Acciaio inossidabile, opaco, con supporto doccia Nylon, grigio scuro

NOSAG	SGVSB Team	Sanitas Troesch	A	B	C
NXD1.1051.583.L		4722 527	1200	500	80
NXD1.1051.583.R		4722 528	1200	500	80



Abbildung in linker Ausführung (.L)  
Image execution gauche (.L)  
Immagine versione sinistra (.L)



**Duschhandlauf** Edelstahl, matt gebürstet

**Barre d'appui d'angle** Acier inoxydable, mat

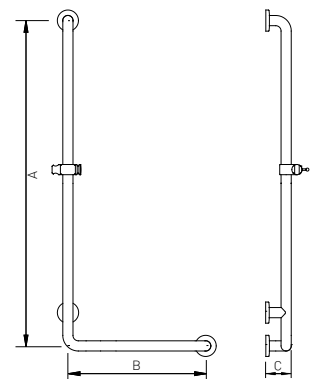
**Corrimano ad angolo** Acciaio inossidabile, opaco

**Max. 175 kg**

NOSAG	SGVSB Team	Sanitas Troesch	A	B	C
NXD2.1001.583			400	750	
NXD2.1002.583		4722 541	750	750	

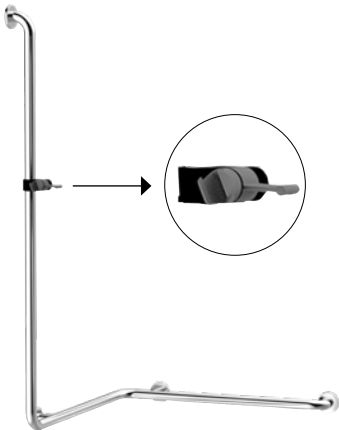
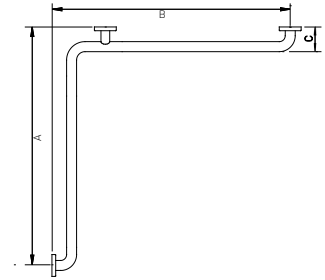

**Duschhandlauf mit Brausestange** Edelstahl, matt gebürstet, mit Brausehalter Nylon dunkelgrau

**Barre d'appui d'angle** Acier inoxydable, mat, avec support à rotule nylon gris foncé

**Corrimano ad angolo con asta per doccia** Acciaio inossidabile, opaco, supporto doccia Nylon grigio scuro

**Max. 175 kg**

NOSAG	SGVSB Team	Sanitas Troesch	A	B	C
NXD2.1102.583.L		4722 551	1200	750	
NXD2.1102.583.R		4722 552	1200	750	



Abbildung in linker Ausführung (.L)  
Image execution gauche (.L)  
Immagine versione sinistra (.L)



Abbildung in linker Ausführung (.L)  
Image execution gauche (.L)  
Immagine versione sinistra (.L)

**Duschhandlauf mit Brausestange** Edelstahl, matt gebürstet, mit Brausehalter Nylon, dunkelgrau

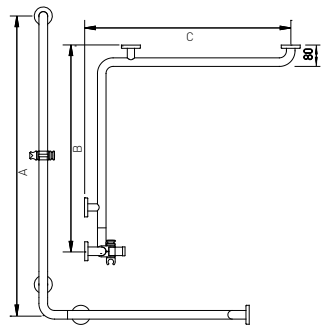
**Barre d'appui d'angle** Acier inoxydable, mat, avec support à rotule nylon, gris foncé

**Corrimano ad angolo con asta per doccia** Acciaio inossidabile, opaco, supporto doccia Nylon, grigio scuro

**Max. 175 kg**

NOSAG	SGVSB Team	Sanitas Troesch	A	B	C
NXD2.1202.583.L		4722 548	1200	750	750
NXD2.1202.583.R		4722 549	1200	750	750

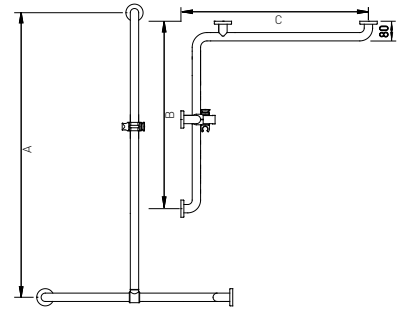

**Duschhandlauf T-Form** Edelstahl, matt gebürstet, mit Brausehalter Nylon, dunkelgrau

**Barre d'appui en T** Acier inoxydable, mat, avec support à rotule nylon, gris foncé

**Corrimano a forma-T** Acciaio inossidabile, opaco, supporto doccia Nylon, grigio scuro

**Max. 175 kg**

NOSAG	SGVSB Team	Sanitas Troesch	A	B	C
NXD2.1051.583			1200	500	250

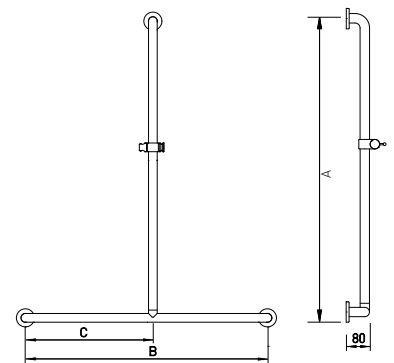



**Duschablage** Nylon, dunkelgrau, zum Anklemmen, mit Ablaufloch

**Tablette de douche** Nylon, gris foncé, à clipser barre d'appui, avec écoulement

**Cestino da doccia** Nylon, grigio scuro, da incastro, con deflusso

NOSAG	SGVSB Team	Sanitas Troesch	A	B	C
NDA.3127.			50	160	80

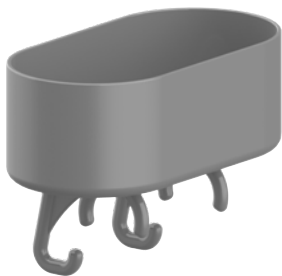
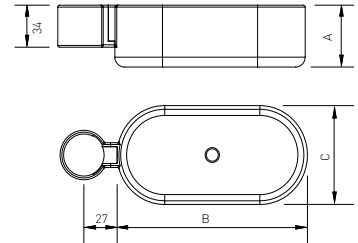
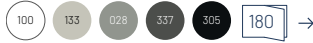

**Duschablage** Nylon, zum Auflegen

**Tablette de douche** Nylon, pour poser sur barre d'appui

**Cestino da doccia** Nylon, a mettere

NOSAG	SGVSB Team	Sanitas Troesch	A	B	C
NDA.4113.	586 241	4721 151	75	210	110

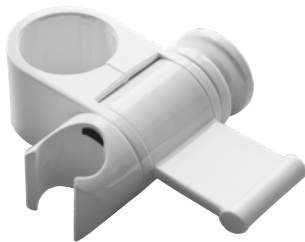
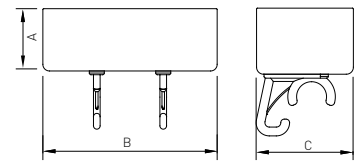

**Brausehalter** Nylon, d = 32 mm

**Support à rotule** Nylon, d = 32 mm

**Supporto doccia** Nylon, d = 32 mm

NOSAG	SGVSB Team	Sanitas Troesch	A	B	C
NDA.4000.	585 116		50	205	80

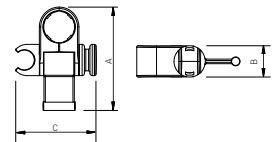



Nylon, Edelstahl Optik, mit Fallsicherung, für Wandmontage, Sitzpolster schwarz

Nylon, optique acier mat, avec frein de sécurité, montage mural, rembourrage noir

Nylon, acciaio ottica inox, con freno di sicurezza, montaggio a muro, sedile imbottito nero

**Max. 175 kg**

NOSAG	SGVSB Team	Sanitas Troesch	A	B	C
ND3.4110.583	4721555		410	320	90

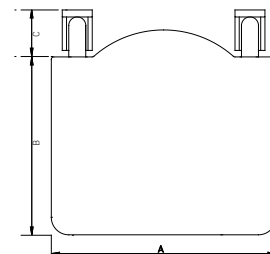

**Montagesets** | Sets de montage | Set di montaggio

für | pour | per

**Lochziegelsteine**

Brique

Mattone forato

**Vorwandssysteme**

Murs préfabriqués

Muri prefabbricati

**Beton**

Béton

Calcestruzzo

**NOSAG**

NM1.0101.000

**SGVSB Team**

4721193

**Sanitas Troesch**

586 392

NM1.0201.000

4721194

586 393

NM1.0301.000

586 391



Nylon, Edelstahl Optik, mit Hygieneausschnitt, für Wandmontage, mit Fallsicherung, Sitzpolster schwarz

Nylon, optique acier mat, avec échancrure, montage mural, avec frein de sécurité, rembourrage noir

Nylon, acciaio ottica inox, con nicchia igiene, montaggio a muro, con freno di sicurezza, sedile imbottito nero

**Max. 175 kg**

NOSAG	SGVSB Team	Sanitas Troesch	A	B	C
ND3.4110.583.A		4721 572	450	360	90

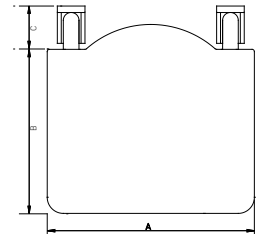

**Montagesets | Sets de montage | Set di montaggio**



für   pour   per	NOSAG	SGVSB Team	Sanitas Troesch
<b>Lochziegelsteine</b>	NM1.0101.000	586 392	4721 193
Brique			
Mattone forato			
<b>Vorwandssysteme</b>	NM1.0201.000	586 393	4721 194
Murs préfabriqués			
Muri prefabbricati			
<b>Beton</b>	NM1.0301.000	586 391	
Béton			
Calcestruzzo			



**Duschklapsitz** Aluminium, Duschklapsitz komplett anthrazit oder Duschklapsitz komplett weiss, für Wandmontage, mit Fallsicherung, **MIT Montageplatte**

**Siège de douche rabattable** Aluminium, siège de douche rabattable complètement anthracite ou siège de douche rabattable complètement blanc, montage mural, avec frein de sécurité, **AVEC plaque de montage**

**Sedile ribaltabile** Alluminio, sedile ribaltabile completamente antracite o sedile ribaltabile completamente bianco, montaggio a muro, con freno di sicurezza, **CON placca di montaggio**

**Max. 150 kg**

NOSAG	SGVSB Team	Sanitas Troesch	A	B	C
ND3.6170.	585 616	4721 785	412	419	512
ND3.6171.			412		419
ND3.6172.			412		419

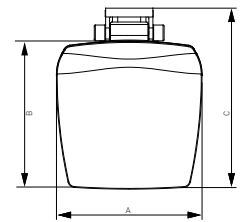

**Montagesets** | Sets de montage | Set di montaggio

für   pour   per	NOSAG	SGVSB Team	Sanitas Troesch
<b>Lochziegelsteine</b> Brique Mattone forato	NM1.0106.000	585 580	4721 795
<b>Vorwandssysteme</b> Murs préfabriqués Muri prefabbricati	NM1.0206.000	585 581	4721 796
<b>Beton</b> Béton Calcestruzzo	NM1.0306.000	585 599	4721 798



**Duschklapsitz Cavere für Rundrohr zum Einhängen** Aluminium, mit Fallsicherung, Polster anthrazit

**Siège de douche rabattable Cavere pour tube rond à suspendre** Aluminium, avec frein de sécurité, rembourrage noir

**Sedile ribaltabile Cavere per tubo tondo per appendere** Alluminio, con freno di sicurezza, sedile imbottito, antracite

**Max. 150 kg**

NOSAG	SGVSB Team	Sanitas Troesch	A	B	C
ND3.6600.	585 410	4721 853	380	563	
ND3.6610.	585 418	4721 854	450	563	

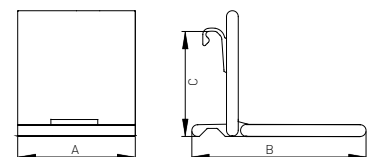

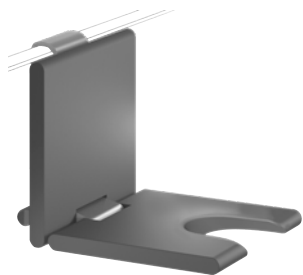

**Duschklappsitz Cavere für Rundrohr zum Einhängen** Aluminium, mit Fallsicherung, mit Hygieneausschnitt, Polster anthrazit

**Siège de douche rabattable Cavere pour tube rond à suspendre** Aluminium, avec frein de sécurité, avec échancrure, rembourrage noir

**Sedile ribaltabile Cavere per tubo tondo per appendere** Alluminio, con freno di sicurezza, sedile imbottito, con nicchia igiene, antracite

**Max. 150 kg**

NOSAG	SGVSB Team	Sanitas Troesch	A	B	C
ND3.6610.-A			450	563	

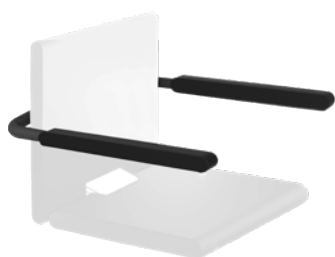
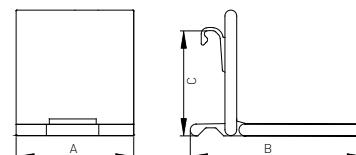

**Armlehnen** Aluminium, nachrüstbar zu Duschklappsitzen Cavere einhängbar, hochklappbar

**Accoudoirs** Aluminium, à monter sur siège Cavere à suspendre, repliable

**Bracciali** Alluminio, attrezzatura per sedile ribaltabile d'appendere Cavere, può essere ripiegato

**Max. 150 kg**

NOSAG	SGVSB Team	Sanitas Troesch	A	B	C
NDA.6301.	585 622	4721 760	590	509	

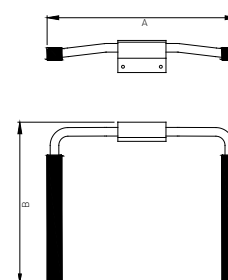

**Duschklappsitz Cavere für Rundrohr zum Einhängen** Aluminium, Duschklappsitz komplett anthrazit oder Duschklappsitz komplett weiss, mit Fallsicherung

**Siège de douche rabattable Cavere pour tube rond à suspendre** Aluminium, siège de douche rabattable complètement anthracite ou siège de douche rabattable complètement blanc, avec frein de sécurité

**Sedile ribaltabile Cavere per tubo tondo per appendere** Alluminio, sedile ribaltabile completamente antracite o sedile ribaltabile completamente bianco, con freno di sicurezza

**Max. 150 kg**

NOSAG	SGVSB Team	Sanitas Troesch	A	B	C
ND3.3581.	585 619	4721 685	412	422	642

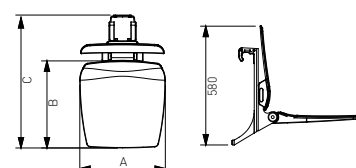



**Duschklapsitz Cavere für Rundrohr zum Einhängen** Aluminium, Duschklapsitz komplett anthrazit oder Duschklapsitz komplett weiss, mit Fallsicherung, mit Armlehnen

**Siège de douche rabattable Cavere pour tube rond à suspendre** Aluminium, siège de douche rabattable complètement anthracite ou siège de douche rabattable complètement blanc, avec frein de sécurité, à suspendre, avec accoudoirs

**Sedile ribaltabile Cavere per tubo tondo per appendere** Alluminio, sedile ribaltabile completamente antracite o sedile ribaltabile completamente bianco, con freno di sicurezza, con braccioli

**Max. 150 kg**

NOSAG	SGVSB Team	Sanitas Troesch	A	B	C
ND3.3582.	585 623	4721 686	412	422	642

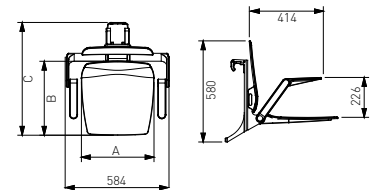

**Duschvorhangstange gerade** Edelstahl, matt gebürstet, mit Vorhangringen Nylon dunkelgrau, auf Mass bestellbar

**Tringle droite pour rideau de douche** Acier inoxydable, mat, avec anneaux, pour rideau nylon gris foncé, peut être commandé sur mesure

**Doccia bastone per tende** Acciaio inossidabile, opaco, con tenda anelli nylon grigio scuro, può essere ordinato su misura

NOSAG	SGVSB Team	Sanitas Troesch	A	B	C
NXD5.1000.583			500 - 1000		
NXD5.1001.583			1001 - 1500		

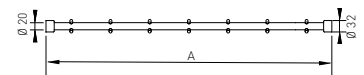



**Duschvorhangstange L-Form** Edelstahl, matt gebürstet, mit Vorhangringen Nylon dunkelgrau, bauseits kürzbar, ohne Deckenabhängung

**Tringle pour rideau de douche form L** Acier inoxydable, mat, avec anneaux pour rideau nylon gris foncé, peut être raccourci par le client, sans fixation pour plafond

**Doccia bastone per tende** Acciaio inossidabile, opaco, con tenda anelli nylon grigio scuro, può essere accorciato sul luogo, senza supporto al plafone

NOSAG	SGVSB Team	Sanitas Troesch	A	B	C
NXD5.1100.583			800	800	
NXD5.1101.583			900	900	
NXD5.1102.583			1000	1000	
NXD5.1103.583			1100	1100	
NXD5.1104.583			1200	1200	
NXD5.1105.583			1300	1300	
NXD5.1108.583			900	1100	
NXD5.1112.583			1000	1200	
NXD5.1106.583			1400	1400	
NXD5.1107.583			1500	1500	

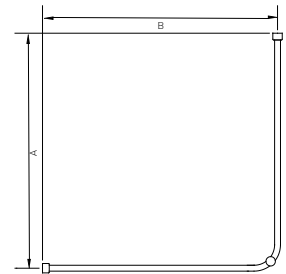

**Deckenabhängung** Edelstahl, matt gebürstet, bauseits kürzbar

**Fixation pour plafond** Acier inoxydable, mat, peut être raccourci par le client

**Supporto al plafone** Acciaio inossidabile, opaco, può essere accorciato sul luogo

NOSAG	SGVSB Team	Sanitas Troesch	A	B	C
NXDA.1805.583			500	32	6
NXDA.1810.583			1000	32	6

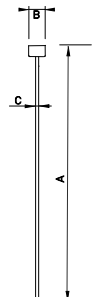

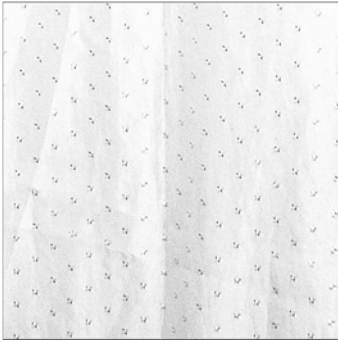

**Duschvorhang** Für Vorhangstangen, 100% Polyester, mit Bleiband, bei 60° waschbar, antibakteriell, weiss mit Struktur

**Rideau de douche** Pour tringles pour rideau de douche, polyester 100%, avec ourlet plombé, lavable à 60°, antibactérien, blanc avec structure

**Tenda per doccia** Per aste da doccia, 100% poliestere, bordo con piombo, lavabile a 60°, antibatterico, bianco con struttura

NOSAG	SGVSB Team	Sanitas Troesch	A	B	C
NDA.5511.019			1200	2000	
NDA.5512.019			1500	2000	
NDA.5500.019		4721 890	2100	2000	
NDA.5501.019	585 630	4721 889	2400	2000	
NDA.5504.019		4721 888	2700	2000	
NDA.5502.019	585 631		3000	2000	
NDA.5503.019	585 632	4721 791	3600	2000	

Mass   mesure   misura	Artikel   article   articolo	Ösen   oeillets   occhielli
1200 × 2000 mm	ND5.1000.	9
1500 × 2000 mm	ND5.1000.	11
2100 × 2000 mm	ND5.1001. ND5.1100.	15
2400 × 2000 mm	ND5.1101 ND5.1102 ND5.1108.	16
2700 × 2000 mm	ND5.1103	18
3000 × 2000 mm	ND5.1104. ND5.1112	20
3600 × 2000 mm		22

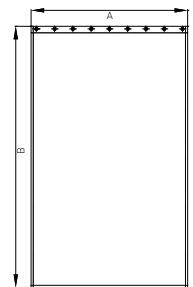



**Duschspritzschutz** Edelstahl, matt gebürstet, mit Fallsicherung, für Wandmontage, **MIT Montageplatte**

**Pare éclaboussure** Acier inoxydable, mat, avec frein de sécurité, montage mural, **AVEC plaque de montage**

**Protezione antischizzo** Acciaio inossidabile, opaco, con freno di sicurezza, montaggio a muro, con placca di montaggio

**Max. 125 kg**

NOSAG	SGVSB Team	Sanitas Troesch	A	B	C
NXD6.1085.583			850	226	110
NXD6.1090.583		4722 558	900	226	110

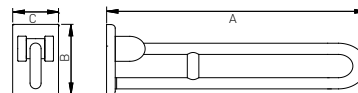

**Montagesets** | Sets de montage | Set di montaggio



für   pour   per	NOSAG	SGVSB Team	Sanitas Troesch
<b>Lochziegelsteine</b> brique mattone forato	NM1.0106.000	585 580	4721 795
<b>Vorwandssysteme</b> murs préfabriqués muri prefabbricati	NM1.0206.000	585 581	4721 796
<b>Beton</b> béton calcestruzzo	NM1.0306.000	585 599	4721 798



**Duschspritzschutzvorhang** 100% Polyester, weiss, mit Bleiband, bei 60° waschbar, mit Klettverschluss

**Rideau pour pare-éclaboussure** Polyester 100%, blanc, avec ourlet plombé, lavable à 60°, blanc avec structure, avec boucles velcro

**Tenda paraspruzzo** 100% poliestere, bordo con piombo, lavabile a 60°, bianco con struttura, passante con velcro

NOSAG	SGVSB Team	Sanitas Troesch	A	B	C
NDA.0777.100	586 012	4721 149	775	620	

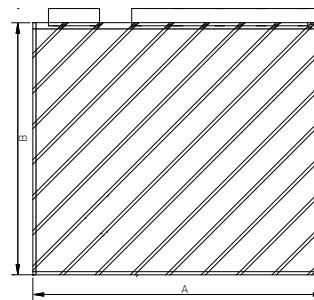

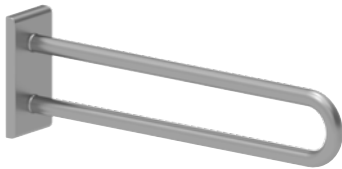

**Stützgriff** Edelstahl, matt gebürstet, **MIT Montageplatte**

**Barre d'appui** Acier inoxydable, mat, **AVEC plaque de montage**

**Impugnatura di supporto** Acciaio inossidabile, opaco, con placca di montaggio

Max. 125 kg

NOSAG	SGVSB Team	Sanitas Troesch	A	B	C
NXL0.1076.583			600	110	226

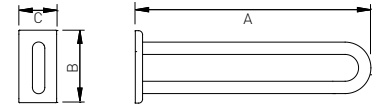

**Montagesets** | Sets de montage | Set di montaggio

für   pour   per	NOSAG	SGVSB Team	Sanitas Troesch
<b>Lochziegelsteine</b> Brique Mattone forato	NM1.0106.000	585 580	4721 795
<b>Vorwandssysteme</b> Murs préfabriqués Muri prefabbricati	NM1.0206.000	585 581	4721 796
<b>Beton</b> Béton Calcestruzzo	NM1.0306.000	585 599	4721 798



**Kippspiegel** Spiegel 500 × 500 mm, Haltestützen Edelstahl matt gebürstet, bis 25° stufenlos verstellbar, ohne Spiegelleuchte

**Miroir inox Carelinabile** Miroir 500 × 500 mm, barre d'appui latérale en acier inoxydable mat, réglable jusqu'à 25°, sans lumière

**Specchio inox Carelinabile** Specchio 500 × 500 mm, supporto acciaio inossidabile opaco, regolabile a 25°, senza illuminazione

NOSAG	SGVSB Team	Sanitas Troesch	A	B	C
NXL2.1000.583		4721 681	500	590	500

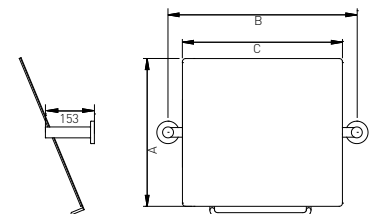

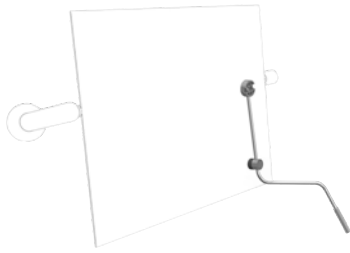

**Bedienungshebel** Edelstahl mit Nylongriff, passend zu Artikel NXL2.1000.583

**Levier de commande** Acier inoxydable, poignée en nylon, adaptable aux articles NXL2.1000.583

**Leva comando** Acciaio con maniglia Nylon, adatto per articolo NXL2.1000.583

NOSAG	SGVSB Team	Sanitas Troesch	A	B	C
NXLA.1800.583			434	312	286

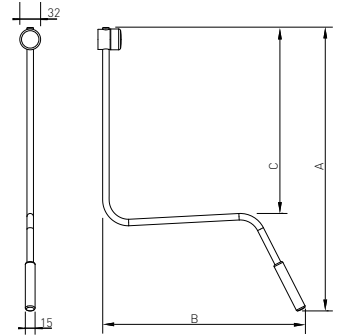

**Ablage** Plattenhalter Edelstahl, matt gebürstet, mit Glasplatte

**Tablette en verre** Support mural en acier inoxydable, mat, avec tablette en verre

**Mensola in vetro** Acciaio inossidabile, opaco, lastra di vetro

NOSAG	SGVSB Team	Sanitas Troesch	A	B	C
NXLA.1505.583			500	49	141

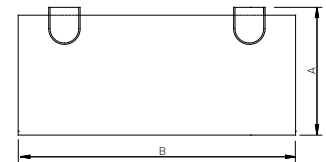

**Wandhaken** Edelstahl, matt gebürstet

**Crochet mural** Acier inoxydable, mat

**Gancio portasciugamani** Acciaio inossidabile, opaco

NOSAG	SGVSB Team	Sanitas Troesch	A	B	C
NLA.1700.583		4721 635	40		

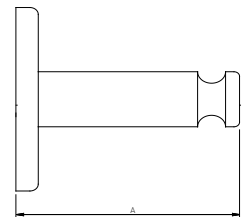

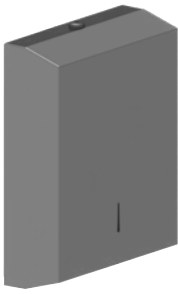

**Papierhandtuchspender** 105 x 282 x 371 mm, Edelstahl hochglanzpoliert, für Wandmontage

**Distributeur d'essuie-mains** 105 x 282 x 371 mm, Acier inoxydable poli brillant, montage mural

**Distributore die asciugamani** 105 x 282 x 371 mm, Acciaio inox, altamente lucidato, per montaggio a parete

NOSAG	SGVSB Team	Sanitas Troesch	A	B	C
NXLA.1400			105	282	371
NXLA.1319			229	93	322

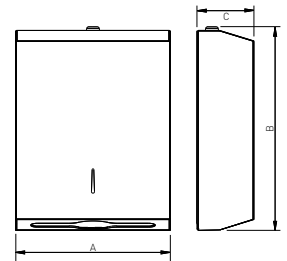

**Washbecken** aus Mineralguss, mit porenfreier Oberfläche, weiss, ohne Überlauf, mit Hahnloch, ohne Armatur und Siphon, ohne Montageset

**Lavabo** en front minérale, surface non poreuse, blanc, sans trop-plein, avec percage pour robinetterie, sans armature et siphon, sans set de montage

**Lavamani** in mineralmarmo, superficie senza porosita, bianco, senza troppopieno, con foro per rubinetteria, senza rubinetto e sifone, senza set di montaggio

NOSAG	SGVSB Team	Sanitas Troesch	A	B	C
NL9.5056.100		3132101	600	550	100





Abbildung in linker Ausführung (.L)  
Image execution gauche (.L)  
Immagine versione sinistra (.L)

**Winkelgriff** Edelstahl, matt gebürstet, 135°

**Poignée latérale** Acier inoxydable, mat, 135°

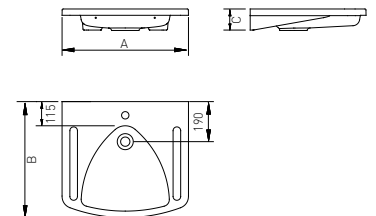
**Corrimano ad angolo** Acciaio inossidabile, opaco, 135°

**Max. 175 kg**

NOSAG	SGVSB Team	Sanitas Troesch	A	B	C
NXB1.1044.583.L		4722 511	400	400	80
NXB1.1044.583.R		4722 512	400	400	80

