

Nylon N300





Nylon, Oberfläche glatt

nylon, tube lisse

Nylon, superficie liscia

Qualitätsmerkmale

Material

- Polyamid Nylon
- Rohrdurchmesser 34 mm
- Materialstärken 4 mm

Masse

- Wandabstand – Achse Rohr 67 mm
- Abdeckrosette D = 71 mm
- Montageflansch D = 66 mm

Alle Masse sind Achse – Achse gemessen (Ausnahme, die Duschhandläufe sind Achse – Wand gemessen)

→ Unsere Masszeichnungen finden Sie unter www.nosag.ch/download

Für Spezialanfertigungen bitte die Vorlagen für Massangaben auf unserer Internetseite benutzen.

Montage

- Bohrschablonen auf Anfrage erhältlich
- Alle Produkte werden mit verdeckter Montage geliefert
- Für alle klappbaren Produkte und die Stützgriffe muss das Montagematerial entsprechend des Mauerwerks bestellt werden. Bei den restlichen Produkten wird das Montagematerial mitgeliefert.

Alle Winkelgriffe und Duschhandläufe sind in die linke und rechte Ausführung drehbar.

Signes de qualité

Matériaux

- polyamide nylon
- diamètre 34 mm
- épaisseur du matériau 4 mm

Mesures

- distance du mur au tube 67 mm
- rosace D = 71 mm
- rosace perforée D = 66 mm

Toutes les dimensions sont mesurées d'axe en axe des tubes (exception: les barres d'appui d'angle sont mesurées axe-mur)

→ Vous trouvez nos plans sous www.nosag.ch/download

Pour toutes demandes de barre sur mesure, veuillez remplir le formulaire mis à disposition sur notre site

Montage

- Chablon de perçage sur demande.
- Tous les produits sont livrés avec montage invisible
- Pour les produits rabattables et barre d'appui mural les fixation au mur sont à définir suivant la nature du support. Pour les autres produits, le matériel de montage est fourni.

Toutes les poignées de sécurité et barre d'appui d'angle peuvent être tournées vers la gauche ou vers la droite.

Caratteristiche qualitative

Materiale

- Poliammide Nylon
- Diametro tubolare 34 mm
- Spessori del materiale 4 mm

Misure

- Distanza dalla parete – Asse del tubolare 67 mm
- Rosetta di copertura D = 71 mm
- Flangia di montaggio D = 66 mm

Tutte le misure sono calcolate da asse ad asse (eccezione, i maniglioni per doccia sono misurati da asse a parete)

→ I nostri disegni tecnici quotati sono disponibili sul sito www.nosag.ch/download

Per realizzazioni su ordinazione utilizzare i modelli per l'indicazione delle misure disponibili sul nostro sito Internet

Montaggio

- Su richiesta sono disponibili dime per la foratura
- Tutti i prodotti vengono forniti con elementi di montaggio nascosti
- Per tutti i prodotti ribaltabili e le impugnature di supporto il materiale per il montaggio deve essere ordinato in base al tipo di muratura Per i prodotti restanti il materiale di fissaggio è incluso.

Tutti maniglioni angolari e i maniglioni per doccia sono raffigurati nella versione sinistra dal punto di vista dell'installatore



Haltegriff Nylon, mit glatter Oberfläche

Barre d'appui Nylon, tube lisse

Corrimano Nylon, liscio

Max. 125 kg



NOSAG	SGVSB Team	Sanitas Troesch	A	B	C
NW0.3003.	586 021	4721601	300		84
NW0.3004.	586 022	4721602	400		84
NW0.3005.			500		84
NW0.3006.	586 023	4721604	600		84
NW0.4108.-G	586 024		800		84
NW0.4110.-G	586 025		1000		84

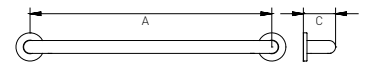

Winkelgriff Nylon, mit glatter Oberfläche

Poignées de sécurité Nylon, tube lisse

Corrimano ad angolo Nylon, liscio

Max. 125 kg



NOSAG	SGVSB Team	Sanitas Troesch	A	B	C
NW1.3033.	586 124	4721621	360	360	84

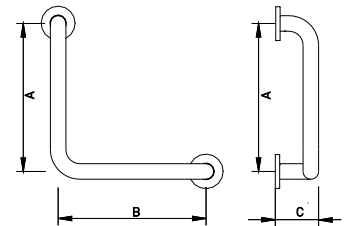



Winkelgriff Nylon, mit glatter Oberfläche

Poignées de sécurité Nylon, tube lisse

Corrimano ad angolo Nylon, liscio

Max. 125 kg

NOSAG	SGVSB Team	Sanitas Troesch	A	B	C
NW1.3037.	586 125	4721 623	700	360	84
NW1.3059.	586 126	4721 624	950	500	84

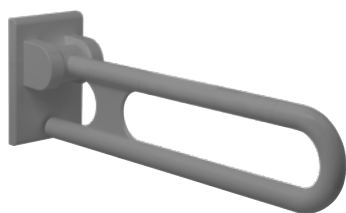
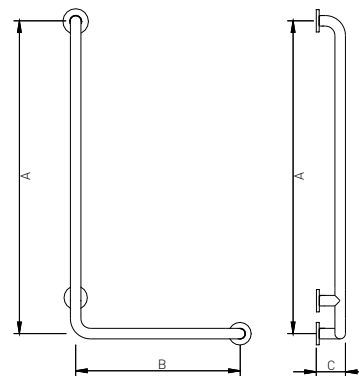
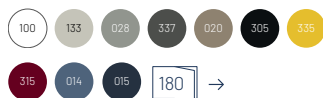

Stützklappgriff Nylon, mit glatter Oberfläche, mit Fallsicherung, **MIT Montageplatte**

Barre d'appui rabattable Nylon, tube lisse, avec frein de sécurité, **AVEC plaque de montage**

Corrimano ribaltabile Nylon, liscio, con freno di sicurezza, **CON placca di montaggio**

Max. 100 kg

NOSAG	SGVSB Team	Sanitas Troesch	A	B	C
NW2.3106.	586 301	4721 171	600	200	132
NW2.3107.	586 302	4721 172	725	200	132
NW2.3108.	586 303	4721 173	850	200	132

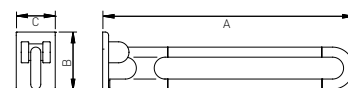
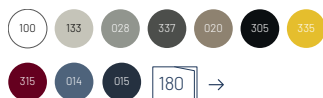

Montagesets | Sets de montage | Set di montaggio



für pour per	NOSAG	SGVSB Team	Sanitas Troesch
Lochziegelsteine Brique Mattone forato	NM1.0100.000	586 396	4721 187
Vorwandssysteme Murs préfabriqués Muri prefabbricati	NM1.0200.000	586 397	4721 188
Beton Béton Calcestruzzo	NM1.0300.000	586 395	

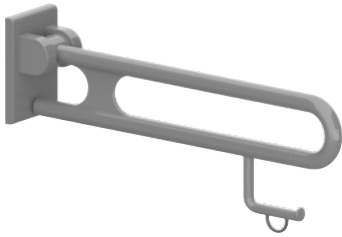

Stützklappgriff Nylon, mit glatter Oberfläche, mit Fallsicherung, mit Papierrollenhalter, **MIT Montageplatte**

Barre d'appui rabattable Nylon, tube lisse, avec frein de sécurité, avec porte-rouleau, **AVEC plaque de montage**

Corrimano ribaltabile Nylon, liscio, con freno di sicurezza, con portacarta, **CON placca di montaggio**

Max. 100 kg



NOSAG	SGVSB Team	Sanitas Troesch	A	B	C
NW2.3016.	586 308	4721 175	600	200	132
NW2.3017.	586 309	4721 176	725	200	132
NW2.3018.	586 310	4721 177	850	200	132

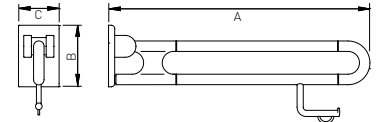

Montagesets | Sets de montage | Set di montaggio



für pour per	NOSAG	SGVSB Team	Sanitas Troesch
Lochziegelsteine Brique Mattone forato	NM1.0100.000	586 396	4721 187
Vorwandssysteme Murs préfabriqués Muri prefabbricati	NM1.0200.000	586 397	4721 188
Beton Béton Calcestruzzo	NM1.0300.000	586 395	



Stützklappgriff Nylon, mit glatter Oberfläche, mit Fallsicherung, mit Fussstütze, **MIT Montageplatte**

Barre d'appui rabattable Nylon, tube lisse, avec frein de sécurité, avec repose-pieds, **AVEC plaque de montage**

Corrimano ribaltabile Nylon, liscio, con freno di sicurezza, con poggiapiedi, **CON placca di montaggio**

Max. 100 kg

NOSAG	SGVSB Team	Sanitas Troesch	A	B	C
NW2.3066.			600	200	132
NW2.3067.			725	200	132
NW2.3068.			850	200	132

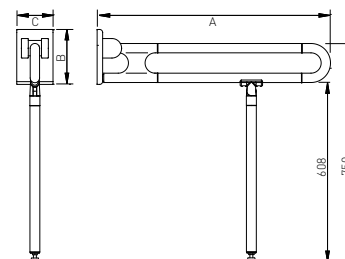
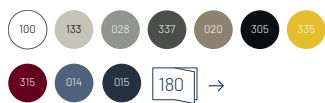

Montagesets | Sets de montage | Set di montaggio

für pour per	NOSAG	SGVSB Team	Sanitas Troesch
Lochziegelsteine Brique Mattone forato	NM1.0100.000	586 396	4721187
Vorwandssysteme Murs préfabriqués Muri prefabbricati	NM1.0200.000	586 397	4721188
Beton Béton Calcestruzzo	NM1.0300.000	586 395	



Stützklappgriff Nylon, mit glatter Oberfläche, mit Fallsicherung, mit Fusstütze, mit Papierrollenhalter, **MIT Montageplatte**

Barre d'appui rabattable Nylon, tube lisse, avec frein de sécurité, avec repose-pieds, avec porte-rouleau, **AVEC plaque de montage**

Corrimano ribaltabile Nylon, liscio, con freno di sicurezza, con poggiapiedi, con portacarta, **CON placca di montaggio**

Max. 100 kg

NOSAG	SGVSB Team	Sanitas Troesch	A	B	C
NW2.3076.			600	200	132
NW2.3077.			725	200	132
NW2.3078.			850	200	132

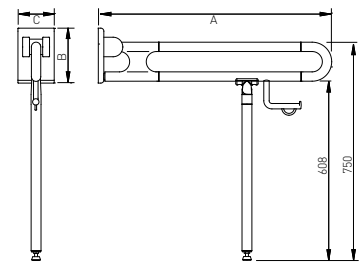
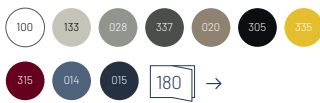

Montagesets | Sets de montage | Set di montaggio

für pour per	NOSAG	SGVSB Team	Sanitas Troesch
Lochziegelsteine Brique Mattone forato	NM1.0100.000	586 396	4721 187
Vorwandssysteme Murs préfabriqués Muri prefabbricati	NM1.0200.000	586 397	4721 188
Beton Béton Calcestruzzo	NM1.0300.000	586 395	



Montageplatte mit Abdeckung Nylon, passend zu Stützklappgriffen

Plaque de montage avec couvercle Nylon, compatible avec les barres d'appui rabattable

Placca di montaggio con copertura Nylon, adattato per corrimano ribaltabili

NOSAG	SGVSB Team	Sanitas Troesch	A	B	C
NWA.3111.	586 320	4721 179	200	132	

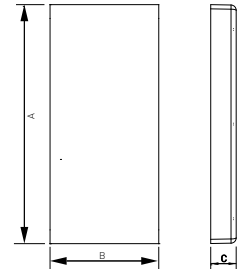

Montagesets | Sets de montage | Set di montaggio



für pour per	NOSAG	SGVSB Team	Sanitas Troesch
Lochziegelsteine Brique Mattone forato	NM1.0100.000	586 396	4721 187
Vorwandssysteme Murs préfabriqués Muri prefabbricati	NM1.0200.000	586 397	4721 188
Beton Béton Calcestruzzo	NM1.0300.000	586 395	



Rückenstütze Nylon, weiss (100), manhattan (133), dunkelgrau (337) oder schwarz (305), mit Rückenkissen schwarz

Dossier Nylon, blanc (100), manhattan (133), gris foncé (337) ou noir (305), avec rembourrage noir

Schienale Nylon, bianco (100), manhattan (133), grigio scuro (337) o nero (305), schienale imbottito nero

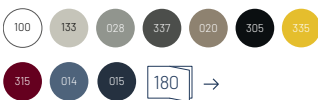

NOSAG	SGVSB Team	Sanitas Troesch	A	B	C
NWA.3410.	586 411	4721 198	577	402	210

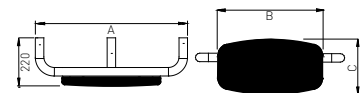



Papierrollenhalter Nylon

Porte-rouleau Nylon

Portacarta Nylon

NOSAG	SGVSB Team	Sanitas Troesch	A	B	C
NWA.4100.	537 861	4721 261	125	160	

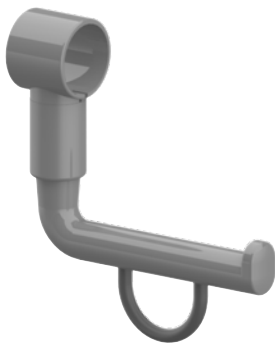
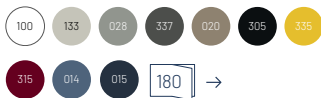
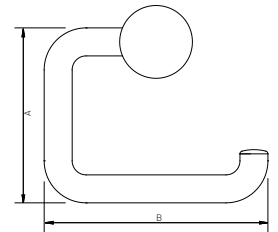

Papierrollenhalter (mit Abrollbremse) Nylon, mit Abrollbremse

Porte-rouleau avec arrêt Nylon, avec arrêt

Portacarta con freno Nylon, con freno

NOSAG	SGVSB Team	Sanitas Troesch	A	B	C
NWA.4112.	586 333	4721 192	120	143	

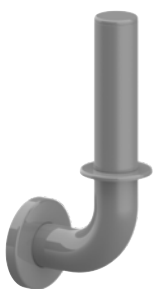
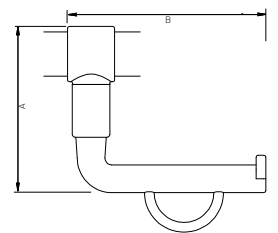

Ersatzrollenhalter Nylon, für 1 Rolle

Porte-rouleau de réserve Nylon, pour 1 rouleau

Portacarta di riserva Nylon, per 1 rotolo

NOSAG	SGVSB Team	Sanitas Troesch	A	B	C
NWA.4203.			190	107	70

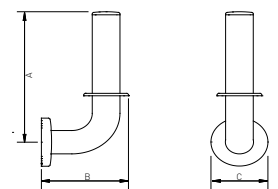



Ersatzrollenhalter Nylon, für 2 Rollen

Porte-rouleau de réserve Nylon, pour 2 rouleaux

Portacarta di riserva Nylon, per 2 rotoli

NOSAG	SGVSB Team	Sanitas Troesch	A	B	C
NWA.4202.	586.336	4721.264	290	107	70

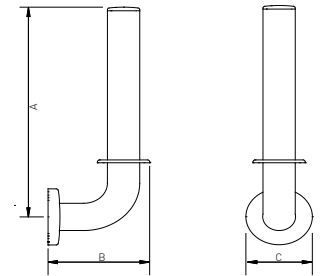
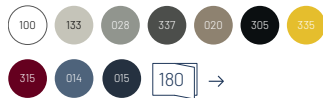

Bürstengarnitur Nylon

Ensemble brosse WC Nylon

Portaspazzola Nylon

NOSAG	SGVSB Team	Sanitas Troesch	A	B	C
NWA.3301.	537.865	4721.267	512	135	148

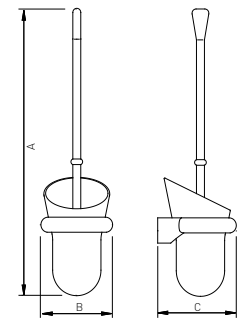
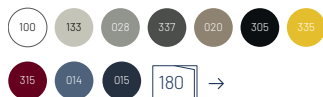

Piktogramm | Pictogramme | Pittogramma



Männliche Person Nylon

Personnage masculin Nylon

Signori Nylon

NOSAG	SGVSB Team	Sanitas Troesch	A	B	C
NWA.4710.			50	130	

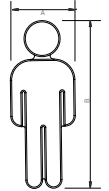

Weibliche Person Nylon

Personnage féminin Nylon

Signore Nylon

NOSAG	SGVSB Team	Sanitas Troesch	A	B	C
NWA.4711.			50	130	

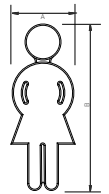

IV-WC Nylon

Toilette pour handicapés Nylon

Andicap Nylon

NOSAG	SGVSB Team	Sanitas Troesch	A	B	C
NWA.4712.			111	130	

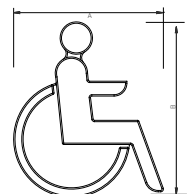

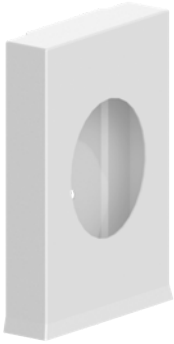

Hygienebeutelspender Edelstahl, pulverbeschichtet

Distributeur de sachets hygiéniques Acier inoxydable, thermolaqué

Distributore di sacchetti igiene Acciaio inossidabile, verniciatura a polvere

NOSAG	SGVSB Team	Sanitas Troesch	A	B	C
NWA.6500.			136	95	27

Dazugehöriger Artikel | Article correspondant | Articoli correlati

Hygienebeutel (30 Stk.)

MWV.TAA901.000

Sachets hygiéniques (30 pcs.)

Sacchetti igienici (30 pz.)

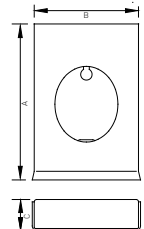

Brausestange Nylon, mit glatter Oberfläche, mit Brausehalter

Glissières de douche Nylon, tube lisse, avec support à rotule

Asta per doccia Nylon, liscio, con supporto doccia

Max. 125 kg

NOSAG	SGVSB Team	Sanitas Troesch	A	B	C
NDO.3006.			600		84
NDO.3010.	586 457	4721 631	1086		84

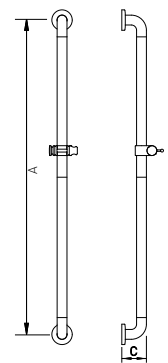



Winkelgriff mit Brausestange Nylon, mit glatter Oberfläche, mit Brausehalter

Barre d'appui avec glissière de douche Nylon, tube lisse, avec support à rotule

Corrimano ad angolo con asta doccia Nylon, liscio, con supporto doccia

Max. 175 kg

NOSAG	SGVSB Team	Sanitas Troesch	A	B	C
ND1.3041.	586 128	4721625	1086	460	84

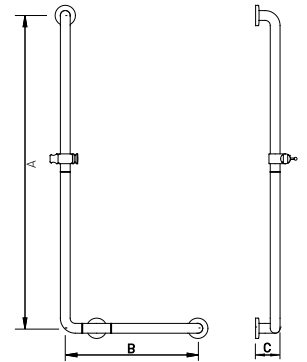

Duschhandlauf T-Form Nylon, mit glatter Oberfläche, mit Brausehalter, Brausestange verschiebbar

Barre d'appui en T Nylon, tube lisse, avec support à rotule, barre verticale coulissante

Corrimano a forma-T Nylon, liscio, con asta per doccia, asta per doccia scorrevole

Max. 175 kg

NOSAG	SGVSB Team	Sanitas Troesch	A	B	C
ND2.3091.		4721645	1158	943	84

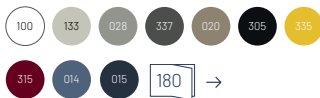
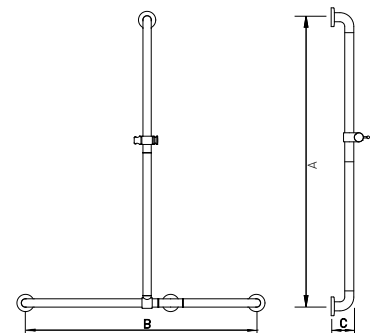



Duschhandlauf Nylon, mit glatter Oberfläche

Barre d'appui d'angle Nylon, tube lisse

Corrimano ad angolo Nylon, liscio

Max. 175 kg



NOSAG	SGVSB Team	Sanitas Troesch	A	B	C
ND2.3001.			427	767	84
ND2.3002.		4721 641	767	767	84

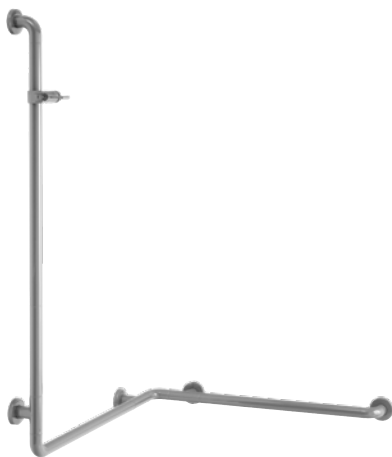
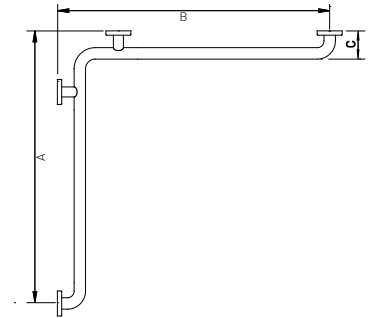

Duschhandlauf mit Brausestange Nylon, mit glatter Oberfläche, mit Brausehalter

Barre d'appui d'angle avec glissière de douche Nylon, tube lisse, avec support à rotule

Corrimano ad angolo con asta per doccia Nylon, liscio, con supporto doccia

Max. 175 kg

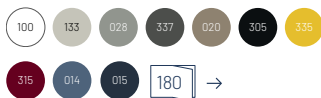

NOSAG	SGVSB Team	Sanitas Troesch	A	B	C
ND2.3102.	586 207	4721 648	1158	767	767

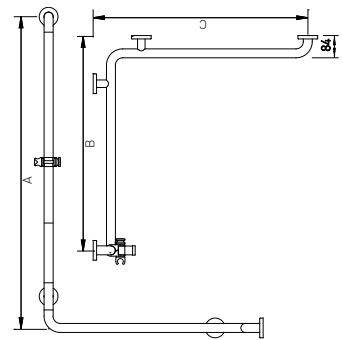



Duschhandlauf mit Brausestange Nylon, mit glatter Oberfläche, mit Brausehalter, Brausestange verschiebbar

Barre d'appui d'angle avec glissière de douche Nylon, tube lisse, avec support à rotule, barre verticale coulissante latérale

Corrimano ad angolo con asta per doccia Nylon, liscio, con supporto doccia, asta per doccia scorrevole

Max. 175 kg

NOSAG	SGVSB Team	Sanitas Troesch	A	B	C
ND2.3202.	586 208	4721 649	1158	767	767
ND2.3203.			1158	1012	767

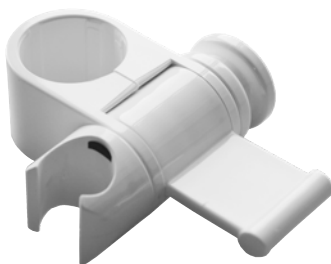
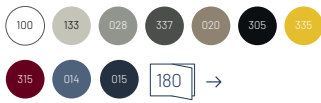
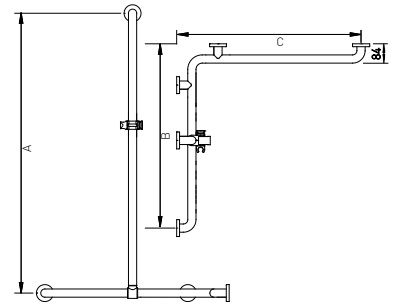

Brausehalter Nylon, d = 34 mm

Support à rotule Nylon, d = 34 mm

Supporto doccia Nylon, d = 34 mm

NOSAG	SGVSB Team	Sanitas Troesch	A	B	C
NDA.4010.			112	34	90

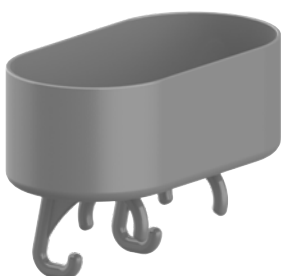
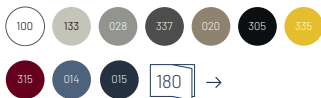
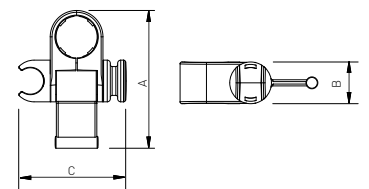

Duschablage Nylon, zum Auflegen

Tablette de douche Nylon, pour poser sur barre d'appui

Cestino da doccia Nylon, a mettere

NOSAG	SGVSB Team	Sanitas Troesch	A	B	C
NDA.4113.	586 241	4721 151	75	210	110

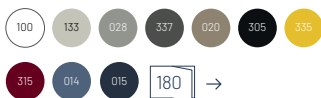
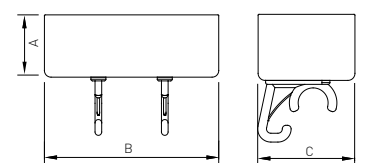



Duschablage Nylon, zum Anklemmen, mit Ablaufloch

Tablette de douche Nylon, montage à la barre d'appui, avec écoulement

Cestino da doccia Nylon, da incastro, con deflusso



NOSAG	SGVSB Team	Sanitas Troesch	A	B	C
NDA.3125.	585 579	4721 647	50	160	80

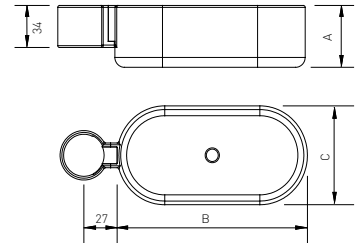

Duschklappsitz, komplett anthrazit oder weiss Aluminium, für Wandmontage, mit Fallsicherung, **MIT Montageplatte**

Siège de douche, complètement anthracite ou blanc Aluminium, pour montage mural, avec sécurité anti-chute, **AVEC plaque de montage**

Sedile doccia, completamente antracite o bianco Alluminio, per montaggio a muro, con sicurezza anticaduta, **CON placca di montaggio**

Max. 150 kg



NOSAG	SGVSB Team	Sanitas Troesch	A	B	C
ND3.6170.	585 616	4721 785	412	419	512
ND3.6171.			412	422	512

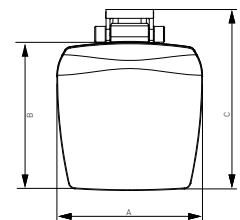



Duschklappsitz Aluminium, mit Armlehnen, für Wandmontage, mit Fallsicherung, **MIT Montageplatte**

Siège de douche rabattable Aluminium, avec accoudoirs, montage mural, avec frein de sécurité, **AVEC plaque de montage**

Sedile ribaltabile da doccia Alluminio, braccioli, montaggio a muro, con freno di sicurezza, **CON placca di montaggio**

Max. 150 kg

NOSAG	SGVSB Team	Sanitas Troesch	A	B	C
ND3.6172.			412	422	512

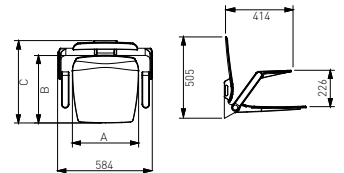

Montagesets | Sets de montage | Set di montaggio



für pour per	NOSAG	SGVSB Team	Sanitas Troesch
Lochziegelsteine Brique Mattone forato	NM1.0106.000	585 580	4721 795
Vorwandssysteme Murs préfabriqués Muri prefabbricati	NM1.0206.000	585 581	4721 796
Beton Béton Calcestruzzo	NM1.0306.000	585 599	4721 798

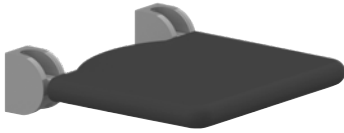

Duschklappsitz Nylon, mit Fallsicherung, für Wandmontage, Sitzpolster schwarz

Siège de douche rabattable Nylon, avec frein de sécurité, montage mural, rembourrage noir

Sedile ribaltabile Nylon, con freno di sicurezza, montaggio a muro, sedile imbottito nero

Max. 175 kg



NOSAG	SGVSB Team	Sanitas Troesch	A	B	C
ND3.3110.			410	320	90

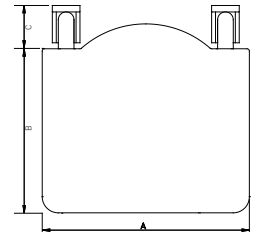

Montagesets | Sets de montage | Set di montaggio

für pour per	NOSAG	SGVSB Team	Sanitas Troesch
Lochziegelsteine Brique Mattone forato	NM1.0101.000	586 392	4721193
Vorwandssysteme Murs préfabriqués Muri prefabbricati	NM1.0201.000	586 393	4721194
Beton Béton Calcestruzzo	NM1.0301.000	586 391	



Nylon, mit Fallsicherung, für Wandmontage

Nylon, avec frein de sécurité, montage mural

Nylon, con freno di sicurezza, montaggio alla parete

Max. 175 kg

NOSAG	SGVSB Team	Sanitas Troesch	A	B	C
ND3.4110.-.A	586 401	4721 785	380	315	95

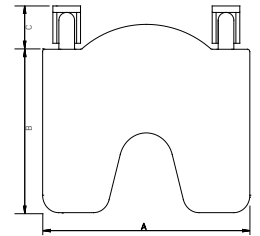

Montagesets | Sets de montage | Set di montaggio

für pour per	NOSAG	SGVSB Team	Sanitas Troesch
Lochziegelsteine	NM1.0101.000	586 392	4721 193
Brique			
Mattone forato			
Vorwandssysteme	NM1.0201.000	586 393	4721 194
Murs préfabriqués			
Muri prefabbricati			
Beton	NM1.0301.000	586 391	
Béton			
Calcestruzzo			



Duschklapsitz Nylon, mit Fallsicherung, für Wandmontage, ND3.4002. mit 5 Leisten

Siège de douche rabattable Nylon, avec frein de sécurité, montage mural, ND3.4002. avec 5 baguettes

Sedile ribaltabile Nylon, con freno di sicurezza, montaggio a muro, ND3.4002. con 5 listelli

Max. 175 kg



NOSAG	SGVSB Team	Sanitas Troesch	A	B	C
ND3.4000.			380	320	90
ND3.4001.			480	320	90
ND3.4002.			480	320	90

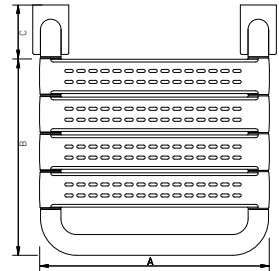

Montagesets | Sets de montage | Set di montaggio



für pour per	NOSAG	SGVSB Team	Sanitas Troesch
Lochziegelsteine Brique Mattone forato	NM1.0101.000	586 392	4721 193
Vorwandssysteme Murs préfabriqués Muri prefabbricati	NM1.0201.000	586 393	4721 194
Beton Béton Calcestruzzo	NM1.0301.000	586 391	



Duschklapsitz zum Einhängen Nylon, mit Fallsicherung, Sitzpolster schwarz

Siège de douche rabattable à suspendre Nylon, avec frein de sécurité, à suspendre, rembourrage noir

Sedile ribaltabile per appendere Nylon, con freno di sicurezza, sedile imbottito, nero

Max. 175 kg

NOSAG	SGVSB Team	Sanitas Troesch	A	B	C
ND3.4510.		4721222	407	321	235

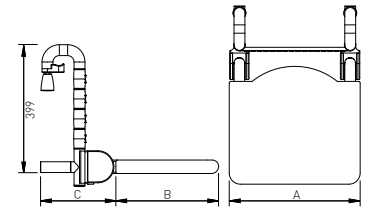

Duschklapsitz Cavere für Rundrohr zum Einhängen Aluminium, mit Fallsicherung, Polster anthrazit

Siège de douche rabattable Cavere pour tube rond à suspendre Aluminium, avec frein de sécurité, rembourrage anthracite

Sedile ribaltabile Cavere per tubo tondo per appendere Alluminio, con freno di sicurezza, sedile imbottito antracite

Max. 150 kg

NOSAG	SGVSB Team	Sanitas Troesch	A	B	C
ND3.6600.	585 410	4721853	380	563	
ND3.6610.	585 418	4721854	450	563	

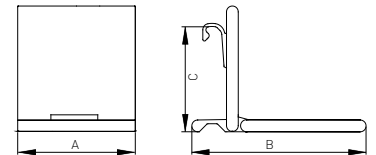

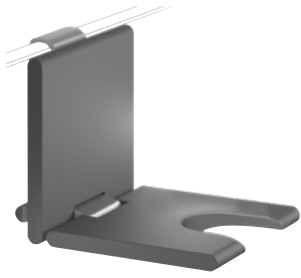

Duschklapsitz Cavere für Rundrohr zum Einhängen Aluminium, mit Fallsicherung, mit Hygieneausschnitt, Polster anthrazit

Siège de douche rabattable Cavere pour tube rond à suspendre Aluminium, avec frein de sécurité, avec échancrure, rembourrage anthracite

Sedile ribaltabile Cavere per tubo tondo per appendere Alluminio, con freno di sicurezza, sedile imbottito, con nicchia igiene antracite

Max. 150 kg

NOSAG	SGVSB Team	Sanitas Troesch	A	B	C
ND3.6610.-A			450	563	

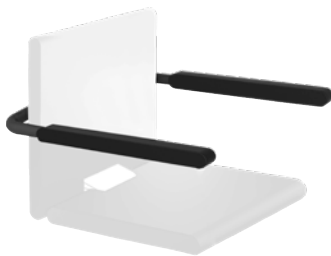
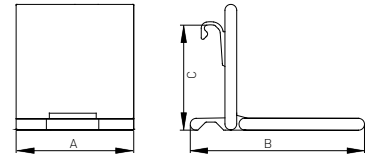

Armlehnen Aluminium, nachrüstbar zu Duschklapsitzen Cavere, einhängbar, hochklappbar

Accoudoirs Aluminium, à monter sur siège Cavere à suspendre, repliable

Braccioli Alluminio, attrezzatura per sedile ribaltabile Cavere, appendibile, richiudibile

NOSAG	SGVSB Team	Sanitas Troesch	A	B	C
NDA.6301.	585 622	4721 760	590	509	

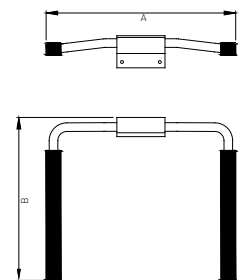

Duschklapsitz Cavere für Rundrohr zum Einhängen Aluminium, Duschklapsitz komplett anthrazit oder komplett weiss, mit Fallsicherung

Siège de douche rabattable Cavere pour tube rond à suspendre Aluminium, siège de douche rabattable complètement anthracite ou complètement blanc, avec frein de sécurité

Sedile ribaltabile Cavere per tubo tondo per appendere Alluminio, sedile ribaltabile completamente antracite o completamente bianco, con freno di sicurezza

Max. 150 kg

NOSAG	SGVSB Team	Sanitas Troesch	A	B	C
ND3.3581.	585 619	4721 685	412	422	642

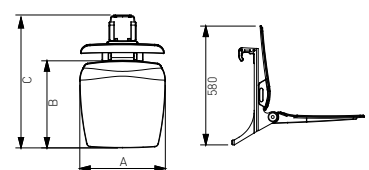
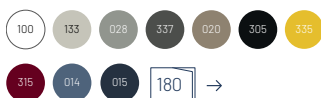



Duschklappsitz Cavere für Rundrohr zum Einhängen Aluminium, Duschklappsitz komplett anthrazit oder komplett weiss, mit Fallsicherung, mit Armlehnen

Siège de douche rabattable Cavere pour tube rond à suspendre Aluminium, siège de douche rabattable complètement anthracite ou complètement blanc, avec frein de sécurité, avec accoudoirs

Sedile ribaltabile Cavere per tubo tondo per appendere Alluminio, sedile ribaltabile completamente antracite o completamente bianco, con freno di sicurezza, con braccioli

Max. 150 kg

NOSAG	SGVSB Team	Sanitas Troesch	A	B	C
ND3.3582.	585 623	4721 686	412	422	642

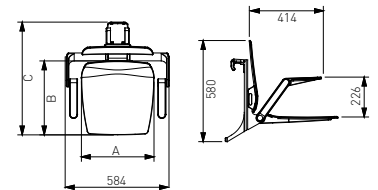

Duschvorhangstange gerade Nylon, mit Vorhangringen, auf Mass bestellbar

Tringle droite pour rideau de douche Nylon, avec anneaux pour rideau, peut être commandé sur mesure

Doccia bastone per tende Nylon, con tenda anelli, può essere ordinato su misura

NOSAG	SGVSB Team	Sanitas Troesch	A	B	C
ND5.4000.			526-1050		
ND5.4001.			1051-1575		
ND5.4002.			1576-2200		

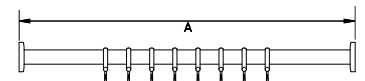
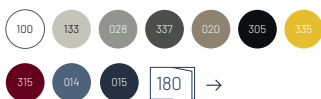

Duschvorhangstange L-Form Nylon, mit Vorhangringen, bauseits kürzbar, ohne Deckenabhängung

Tringle pour rideau de douche form L Nylon, avec anneaux pour rideau, peut être raccourci par le client, sans fixation pour plafond

Doccia bastone per tende Nylon, con tenda anelli, può essere accorciato sul luogo, senza supporto al plafone

NOSAG	SGVSB Team	Sanitas Troesch	A	B	C
ND5.4101.			900	900	
ND5.4191.			900	1100	
ND5.4102.	171 552		1000	1000	
ND5.4104.			1200	1200	
ND5.4112.			1000	1200	
ND5.4107.			1500	1500	

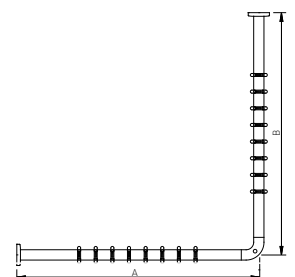
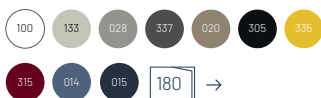



Deckenabhängung Nylon, bauseits kürzbar

Fixation pour plafond Nylon, peut être raccourci par le client

Supporto al plafone Nylon, può essere accorciato sul luogo

NOSAG	SGVSB Team	Sanitas Troesch	A	B	C
NDA.4805.	171553		500		
NDA.4806.			600		
NDA.4810.			1000		

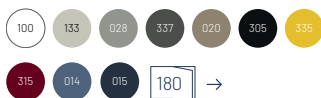

Duschvorhang Für Vorhangstangen, 100% Polyester, mit Bleiband, bei 60° waschbar, antibakteriell, weiss mit Struktur

Rideau de douche Pour tringles pour rideau de douche, polyester 100%, avec ourlet plombé, lavable à 60°, antibactérien, blanc avec structure

Tenda per doccia Per aste da doccia, 100% poliestere, bordo con piombo, lavabile a 60°, antibatterico, bianco con struttura

NOSAG	SGVSB Team	Sanitas Troesch	A	B	C
NDA.5511.019			1200	2000	
NDA.5512.019			1500	2000	
NDA.5500.019		4721 890	2100	2000	
NDA.5501.019	585 630	4721 889	2400	2000	
NDA.5504.019		4721 888	2700	2000	
NDA.5502.019	585 631		3000	2000	
NDA.5503.019	585 632	4721 791	3600	2000	

Mass mesure misura	Artikel article articolo	Ösen oeillets occhielli
1200 × 2000 mm	NDA.5511.	9
1500 × 2000 mm	ND5.4000.	11
2100 × 2000 mm	ND5.4001.	15
2400 × 2000 mm	ND5.4101.	16
2700 × 2000 mm	ND5.4002.	18
3000 × 2000 mm	ND5.4104.	20
3600 × 2000 mm	ND5.4191.	22

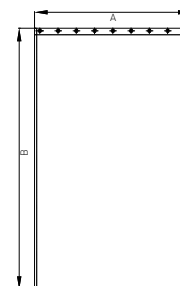

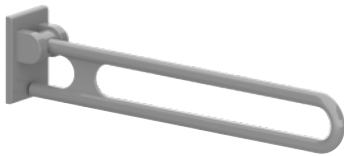

Duschspritzschutz Nylon, mit Fallsicherung, für Wandmontage, **MIT Montageplatte**

Pare-éclaboussure Nylon, avec frein de sécurité, montage mural, **AVEC plaque de montage**

Protezione antischizzo Nylon, con freno di sicurezza, montaggio a muro, **CON placca di montaggio**

Max. 125 kg



NOSAG	SGVSB Team	Sanitas Troesch	A	B	C
ND6.4093.-G	586 010	4721 147	900	200	132

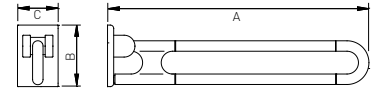

Montagesets | Sets de montage | Set di montaggio

für pour per	NOSAG	SGVSB Team	Sanitas Troesch
Lochziegelsteine Brique Mattone forato	NM1.0100.000	586 396	4721 187
Vorwandssysteme Murs préfabriqués Muri prefabbricati	NM1.0200.000	586 397	4721 188
Beton Béton Calcestruzzo	NM1.0300.000	586 395	



Spritzschutzhvorhang 100% Polyester, mit Bleiband, bei 60° waschbar, weiss mit Struktur, mit Klettverschluss

Rideau pour pare-éclaboussure Polyester 100%, blanc, avec ourlet plombé, lavable à 60°, blanc avec structure, avec boucles velcro

Tenda antischizzo 100% poliestere, bordo con piombo, lavabile a 60°, bianco con struttura, passante con velcro

NOSAG	SGVSB Team	Sanitas Troesch	A	B	C
NDA.0777.100	586 012	4721 149	775	620	

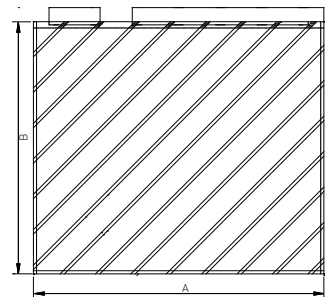

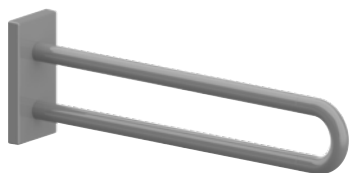

Stützgriff Nylon, mit glatter Oberfläche, **MIT Montageplatte**

Barre d'appui Nylon, tube lisse, **AVEC plaque de montage**

Impugnatura di supporto Nylon, liscio, **CON placca di montaggio**

Max. 125 kg

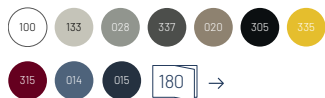

NOSAG	SGVSB Team	Sanitas Troesch	A	B	C
NL0.3006.			600	200	132

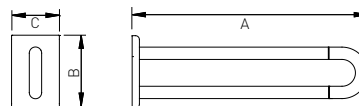

Montagesets | Sets de montage | Set di montaggio



für pour per	NOSAG	SGVSB Team	Sanitas Troesch
Lochziegelsteine Brique Mattone forato	NM1.0100.000	586 396	4721187
Vorwandssysteme Murs préfabriqués Muri prefabbricati	NM1.0200.000	586 397	4721188
Beton Béton Calcestruzzo	NM1.0300.000	586 395	



Kippspiegel Spiegel 500 × 500 mm, Haltestützen Nylon, bis 25° stufenlos verstellbar

Miroir inclinable Miroir 500 × 500 mm, barre d'appui latérale en Nylon, réglable jusqu'à 25°

Inclinazione specchio Specchio 500 × 500 mm, supporto Nylon, regolabile a 25°

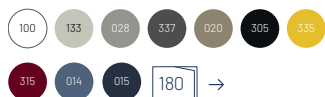

NOSAG	SGVSB Team	Sanitas Troesch	A	B	C
NL2.3000.			500	550	500

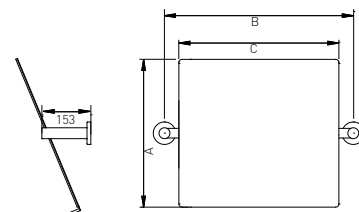



Kippspiegel Spiegel 500 × 500 mm, Haltebügel Nylon, bis 25° stufenlos verstellbar, ohne Spiegelleuchte

Miroir inclinable Miroir 500 × 500 mm, barres d'appui latérales en Nylon, réglable jusqu'à 25°, sans lumière

Inclinazione specchio Specchio 500 × 500 mm, supporto Nylon, regolabile a 25°, senza illuminazione

NOSAG	SGVSB Team	Sanitas Troesch	A	B	C
NL2.4100.		4721200	500	590	148

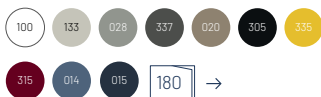
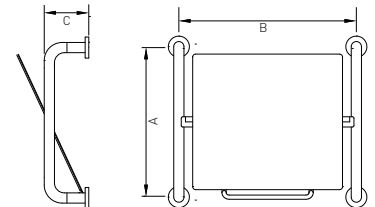

Bedienungshebel Nylon, passend zu Artikel NL2.4100 - Kippspiegel

Levier de commande Nylon, adaptable aux articles NL2.4100 - Miroir inclinable

Leva comando Nylon, adatto per articolo NL2.4100 - Inclinazione specchio

NOSAG	SGVSB Team	Sanitas Troesch	A	B	C
NLA.4800.			240	336	

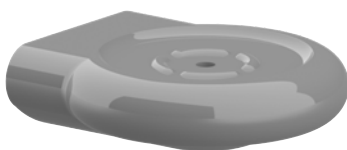
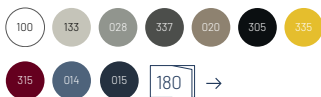
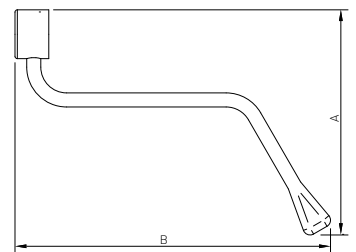

Seifenablage Nylon, ohne Ablauf

Porte-savon Nylon, sans écoulement

Portasapone Nylon, senza a deflusso

NOSAG	SGVSB Team	Sanitas Troesch	A	B	C
NLA.4300.			125	116	39

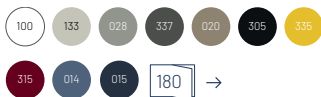
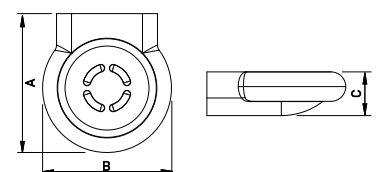

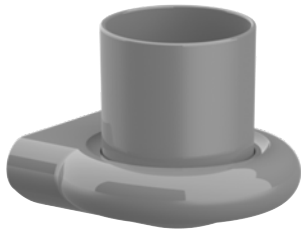

Becherhalter Nylon, mit Becher
Porte-gobelet Nylon, avec gobelet
Portabicchiere Nylon, bicchiere sintetico

NOSAG	SGVSB Team	Sanitas Troesch	A	B	C
NLA.3300.			125	116	122

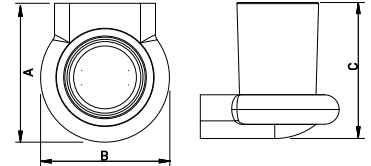

Handtuchhalter Nylon
Porte-serviette Nylon
Portaserviette Nylon

NOSAG	SGVSB Team	Sanitas Troesch	A	B	C
NLA.4600.	537 822		150	220	

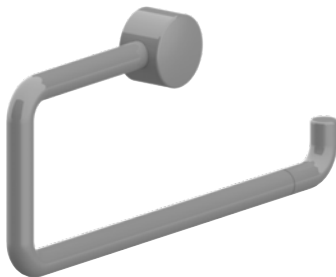
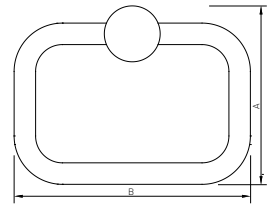

Handtuchhalter Nylon
Porte-serviette Nylon
Portaserviette Nylon

NOSAG	SGVSB Team	Sanitas Troesch	A	B	C
NLA.4610.	537 822		161	360	

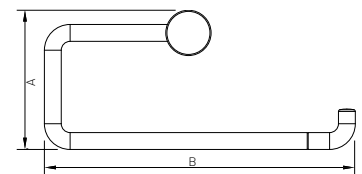
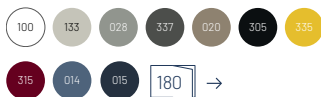



Handtuchhalter Nylon, schwenkbar, 2-armig
Porte-serviette Nylon, orientable, 2 bras
Portasalviette Nylon, 2-braccia, orientabile

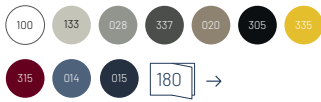

NOSAG	SGVSB Team	Sanitas Troesch	A	B	C
NLA.4620.	537 821		65	450	

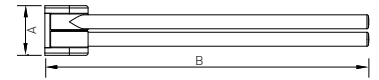

Handtuchhalter Nylon
Porte-serviette Nylon
Portasalviette Nylon

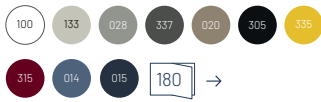

NOSAG	SGVSB Team	Sanitas Troesch	A	B	C
NLA.4630.			71	456	

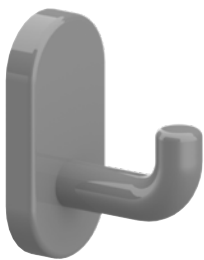
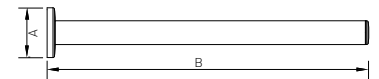

Wandhaken Nylon
Crochet mural Nylon
Gancio portasciugamani Nylon

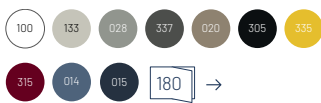

NOSAG	SGVSB Team	Sanitas Troesch	A	B	C
NLA.4700.	537 824		58	44	28
NLA.4701.	537 825		70	66	34

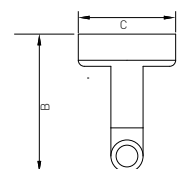
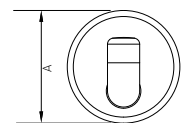

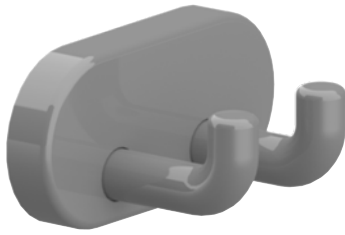

Doppelhaken Nylon

Crochet double Nylon

Gancio doppio Nylon

NOSAG	SGVSB Team	Sanitas Troesch	A	B	C
NLA.4710.	537 827		28	32	58

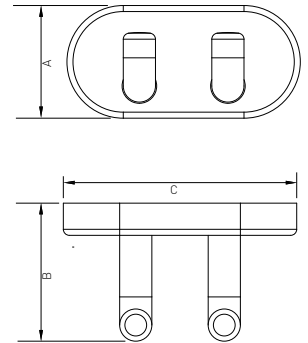

Papierhandtuchspender Metall weiss lackiert, für Wandmontage

Distributeur de serviettes en papier en métal laqué blanc, montage mural

Distributore d'asciugamani metallo, bianco laccato, montaggio a muro

NOSAG	SGVSB Team	Sanitas Troesch	A	B	C
NLA.3400.100			371	282	105

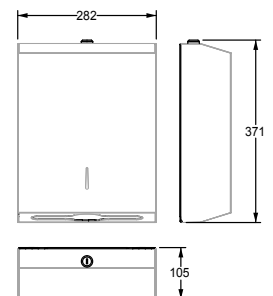

Winkelgriff Nylon, mit glatter Oberfläche, 135°

Poignée latérale Nylon, tube lisse, 135°

Corrimano ad angolo Nylon, liscio, 135°

Max. 125 kg

NOSAG	SGVSB Team	Sanitas Troesch	A	B	C
NB1.3035.			336	579	84

