

Verso Care



Nylon, Oberfläche glatt

nylon, tube lisse

Nylon, superficie liscia



→ **Erhältlich in Farbe** | Disponible en couleur | Disponibile in colore

Qualitätsmerkmale

Material

- Polyamid Nylon
- Rohrdurchmesser 34 mm
- Materialstärken 4 mm

Masse

- Wandabstand – Achse Rohr 62.5 mm

Alle Masse sind Achse – Achse gemessen (Ausnahme, die Duschhandläufe sind Achse – Wand gemessen)

Montage

- Alle Produkte werden mit verdeckter Montage geliefert
- Für alle klappbaren Produkte und die Stützgriffe muss das Montagematerial entsprechend des Mauerwerks bestellt werden. Bei den restlichen Produkten wird das Montagematerial mitgeliefert.

Alle abgebildeten Winkelgriffe und Duschhandläufe sind immer aus Sicht des Monteurs in der Ausführung links.

→ Unsere Masszeichnungen finden Sie unter www.nosag.ch/download

Für Spezialanfertigungen bitte die Vorlagen für Massangaben auf unserer Internetseite benutzen.

Signes de qualité

Matériaux

- polyamide nylon
- diamètre 34 mm
- épaisseur du matériau 4 mm

Mesures

- distance du mur au tube 62.5 mm

Toutes les dimensions sont mesurées d'axe en axe des tubes (exception: les barres d'appui d'angle sont mesurées axe-mur)

Montage

- Tous les produits sont livrés avec montage invisible
- Pour les produits rabattables et barre d'appui mural les fixation au mur sont à définir suivant la nature du support. Pour les autres produits, le matériel de montage est fourni.

Toutes les images des barres d'appui d'angle sont des exécutions gauches du point de vue du monteur.

→ Vous trouvez nos plans sous www.nosag.ch/download

Pour toutes demandes de barre sur mesure, veuillez remplir le formulaire mis à disposition sur notre site

Caratteristiche qualitative

Materiale

- Poliammide Nylon
- Diametro tubolare 34 mm
- Spessori del materiale 4 mm

Misure

- Distanza dalla parete – Asse del tubolare 62.5 mm

Tutte le misure sono calcolate da asse ad asse (eccezione, i maniglioni per doccia sono misurati da asse a parete)

Montaggio

- Tutti i prodotti vengono forniti con elementi di montaggio nascosti
- Per tutti i prodotti ribaltabili e le impugnature di supporto il materiale per il montaggio deve essere ordinato in base al tipo di muratura Per i prodotti restanti il materiale di fissaggio è incluso.

Tutti maniglioni angolari e i maniglioni per doccia sono raffigurati nella versione sinistra dal punto di vista dell'installatore

→ I nostri disegni tecnici quotati sono disponibili sul sito www.nosag.ch/download

Per realizzazioni su ordinazione utilizzare i modelli per l'indicazione delle misure disponibili sul nostro sito Internet



Haltegriff Nylon, mit glatter Oberfläche

Barre d'appui Nylon, tube lisse

Corrimano Nylon, liscio

Max. 125 kg



NOSAG	SGVSB Team	Sanitas Troesch	A	B	C
NW0.3103.	561 274	4722 222	300		80
NW0.3104.	561 275	4722 223	400		80
NW0.3106.	561 276	4722 224	600		80

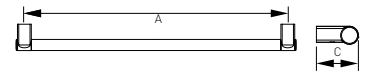

Haltegriff Nylon, mit glatter Oberfläche, geteiltes Nylonrohr

Barre d'appui Nylon, tube lisse, tube en nylon divisé

Corrimano Nylon, liscio, Tubo di nylon diviso

Max. 125 kg



NOSAG	SGVSB Team	Sanitas Troesch	A	B	C
NW0.3108.	561 277	4722 225	800		80
NW0.3110.	561 278	4722 226	1000		80

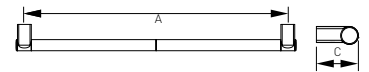

Winkelgriff Nylon, mit glatter Oberfläche

Poignée de sécurité Nylon, tube lisse

Corrimano ad angolo Nylon, liscio

Max. 175 kg

Abbildung in linker Ausführung (.L)
Image execution gauche (.L)
Immagine versione sinistra (.L)



NOSAG	SGVSB Team	Sanitas Troesch	A	B	C
NW1.3133.xxx.L	561 279	4722 227	300	300	80
NW1.3133.xxx.R	561 280	4722 228	300	300	80
NW1.3144.xxx.L	561 281	4722 229	400	400	80
NW1.3144.xxx.R	561 282	4722 230	400	400	80

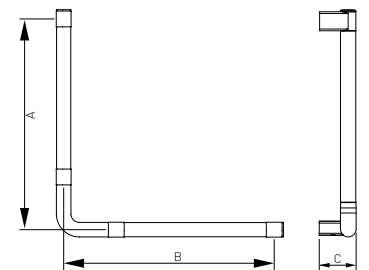



Winkelgriff Nylon, mit glatter Oberfläche

Poignée de sécurité Nylon, tube lisse

Corrimano ad angolo Nylon, liscio

Max. 175 kg

NOSAG	SGVSB Team	Sanitas Troesch	A	B	C
NW1.3147.xxx.L	561 283	4722 231	750	400	
NW1.3147.xxx.R	561 284	4722 232	750	400	
NW1.3159.xxx.L	561 285	4722 233	950	500	
NW1.3159.xxx.R	561 286	4722 234	950	500	

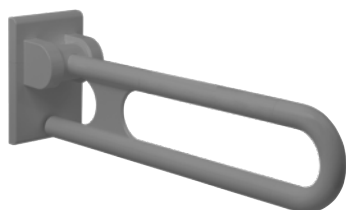
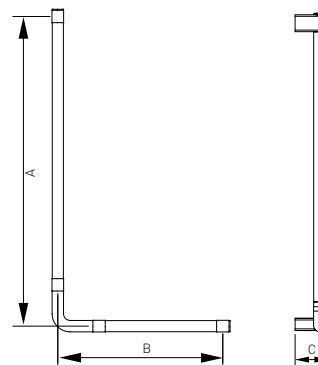
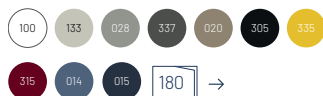

Stützklappgriff Nylon, mit glatter Oberfläche, mit Fallsicherung, **MIT Montageplatte**

Barre d'appui rabattable Nylon, tube lisse, avec frein de sécurité, **AVEC plaque de montage**

Corrimano ribaltabile Nylon, superficie liscia, con freno di sicurezza, **CON placca di montaggio**

Max. 100 kg

NOSAG	SGVSB Team	Sanitas Troesch	A	B	C
NW2.3106.	561 287	4722 235	600	227	115
NW2.3107.	561 288	4722 236	725	227	115
NW2.3108.	561 289	4722 237	850	227	115

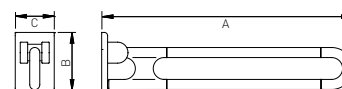
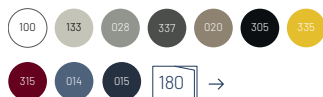

Montagesets | Sets de montage | Set di montaggio

für pour per	NOSAG	SGVSB Team	Sanitas Troesch
Lochziegelsteine Brique Mattone forato	NM1.0106.000	585 580	4721 795
Vorwandssysteme Murs préfabriqués Muri prefabbricati	NM1.0206.000	585 581	4721 796
Beton Béton Calcestruzzo	NM1.0306.000	585 599	4721 798

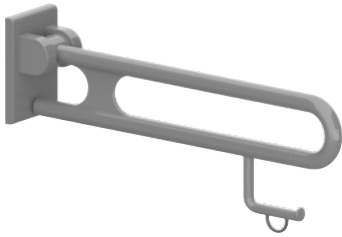

Stützklappgriff Nylon, mit glatter Oberfläche, mit Fallsicherung, mit Papierrollenhalter, **MIT Montageplatte**

Barre d'appui rabattable Nylon, tube lisse, avec frein de sécurité, avec porte-rouleau, **AVEC plaque de montage**

Corrimano ribaltabile Nylon, superficie liscia, con freno di sicurezza, con portacarta, **CON placca di montaggio**

Max. 100 kg



NOSAG	SGVSB Team	Sanitas Troesch	A	B	C
NW2.3116.	561 290	4722 238	600	227	115
NW2.3117.	561 291	4722 239	725	227	115
NW2.3118.	561 292	4722 240	850	227	115

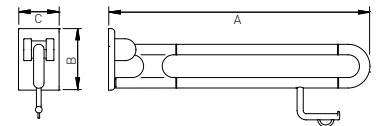

Montagesets | Sets de montage | Set di montaggio

für pour per	NOSAG	SGVSB Team	Sanitas Troesch
Lochziegelsteine Brique Mattone forato	NM1.0106.000	585 580	4721 795
Vorwandssysteme Murs préfabriqués Muri prefabbricati	NM1.0206.000	585 581	4721 796
Beton Béton Calcestruzzo	NM1.0306.000	585 599	4721 798



Stützklappgriff mit Fusstütze Nylon, mit glatter Oberfläche, mit Fallsicherung, Fusstütze verstellbar, **MIT Montageplatte**

Barre d'appui rabattable avec pied Nylon, tube lisse, avec frein de sécurité, pied réglable, **AVEC plaque de montage**

Corrimano ribaltabile con piede Nylon, superficie liscia, con freno di sicurezza, piede d'appoggio regolabile, **CON placca di montaggio**

Max. 100 kg

NOSAG	SGVSB Team	Sanitas Troesch	A	B	C
NW2.3166.			600	227	115
NW2.3167.			725	227	115
NW2.3168.			850	227	115

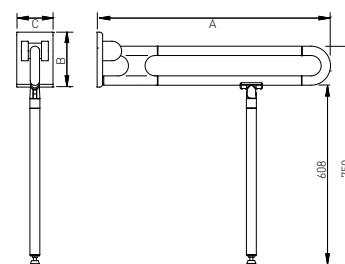
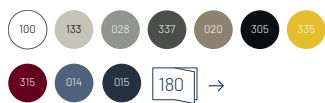

Montagesets | Sets de montage | Set di montaggio



für pour per	NOSAG	SGVSB Team	Sanitas Troesch
Lochziegelsteine Brique Mattone forato	NM1.0106.000	585 580	4721 795
Vorwandssysteme Murs préfabriqués Muri prefabbricati	NM1.0206.000	585 581	4721 796
Beton Béton Calcestruzzo	NM1.0306.000	585 599	4721 798



Stützklappgriff mit Fusstütze Nylon, mit glatter Oberfläche, mit Fallsicherung, Fusstütze verstellbar, mit Papierrollenhalter, **MIT Montageplatte**

Barre d'appui rabattable avec pied Nylon, tube lisse, avec frein de sécurité, pied réglable, avec porte-rouleau, **AVEC plaque de montage**

Corrimano ribaltabile con piede Nylon, superficie liscia, con freno di sicurezza, piede d'appoggio regolabile, con portacarta, **CON placca di montaggio**

Max. 100 kg

NOSAG	SGVSB Team	Sanitas Troesch	A	B	C
NW2.3176.			600	227	115
NW2.3177.			725	227	115
NW2.3178.			850	227	115

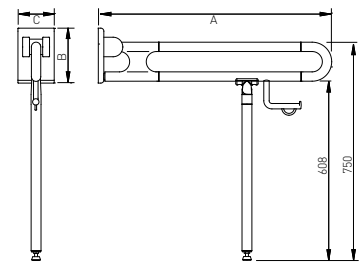
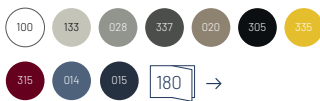

Montagesets | Sets de montage | Set di montaggio

für pour per	NOSAG	SGVSB Team	Sanitas Troesch
Lochziegelsteine Brique Mattone forato	NM1.0106.000	585 580	4721 795
Vorwandssysteme Murs préfabriqués Muri prefabbricati	NM1.0206.000	585 581	4721 796
Beton Béton Calcestruzzo	NM1.0306.000	585 599	4721 798



Rückenstütze Nylon weiss (100), manhattan (133), dunkelgrau oder schwarz, mit Rückenkissen schwarz

Dossier Nylon blanc (100), manhattan (133), gris foncé ou noir, avec rembourrage noir

Schienale Nylon bianco (100), manhattan (133), grigio scuro o nero, schienale imbottito nero

NOSAG	SGVSB Team	Sanitas Troesch	A	B	C
NWA.3410.	586 411	4721198	577	402	210

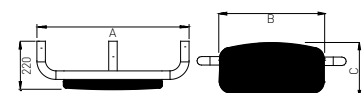

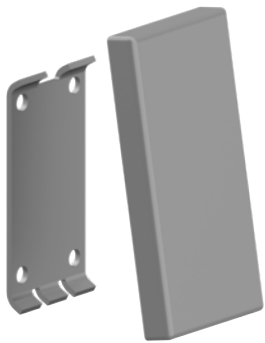

Montageplatte mit Abdeckung Nylon, passend zu Stützklappgriffen

Plaque de montage avec couvercle Nylon, compatible avec la barre d'appui rabattable

Placca di montaggio con copertura Nylon, adattata per il corrimano ribaltabile



NOSAG	SGVSB Team	Sanitas Troesch	A	B	C
NWA.3111.	561 293	4722 241	227	115	24

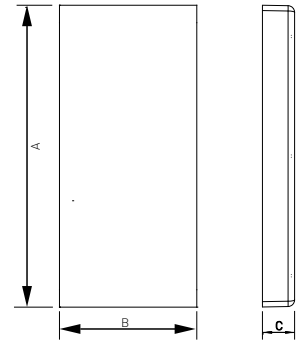

Montagesets | Sets de montage | Set di montaggio

für pour per	NOSAG	SGVSB Team	Sanitas Troesch
Lochziegelsteine Brique Mattone forato	NM1.0106.000	585 580	4721 795
Vorwandssysteme Murs préfabriqués Muri prefabbricati	NM1.0206.000	585 581	4721 796
Beton Béton Calcestruzzo	NM1.0306.000	585 599	4721 798



Papierrollenhalter Nylon, mit Abrollbremse

Porte-rouleau Nylon, avec arrêt

Portacarta Nylon, con freno

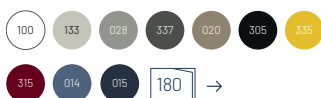

NOSAG	SGVSB Team	Sanitas Troesch	A	B	C
NWA.4112.	586 333	4721 192	120	143	

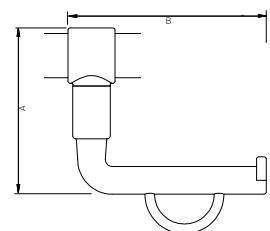



Brausestange Nylon, mit glatter Oberfläche, mit Brausehalter

Glissières de douche Nylon, tube lisse, avec support à rotule

Asta per doccia Nylon, liscio, con supporto doccia

Max. 125 kg

NOSAG	SGVSB Team	Sanitas Troesch	A	B	C
NDO.3106.	561 254	4722 202	600		80
NDO.3109.	561 255	4722 203	900		80
NDO.3112.	561 256	4722 204	1200		80

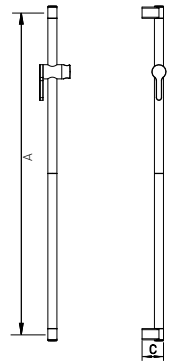

Winkelgriff mit Brausestange Nylon, Brausestange glatte Oberfläche, mit Brausehalter

Barre d'appui avec glissière de douche Nylon, glissière surface tube lisse, avec support à rotule

Corrimano ad angolo con asta doccia Nylon, con asta per doccia, liscia, con supporto doccia

Max. 175 kg

NOSAG	SGVSB Team	Sanitas Troesch	A	B	C
ND1.3151.xxx.L	561 257	4722 205	1200	500	80
ND1.3151.xxx.R	561 258	4722 206	1200	500	80
ND1.3171.xxx.L	561 259	4722 207	1200	700	80
ND1.3171.xxx.R	561 260	4722 208	1200	700	80



Abbildung in linker Ausführung (.L)
Image execution gauche (.L)
Immagine versione sinistra (.L)



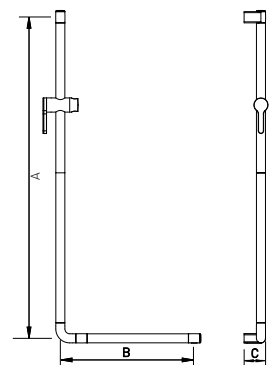
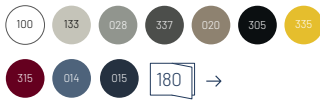
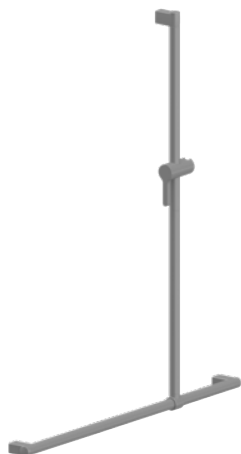

Duschhandlauf T-Form Nylon, mit glatter Oberfläche, mit Brausehalter, Brausestange verschiebbar

Barre d'appui en T Nylon, tube lisse, avec support à rotule, barre verticale coulissante latérale

Corrimano a forma-T Nylon, liscio, con supporto doccia, asta doccia scorrevole

Max. 175 kg

NOSAG	SGVSB Team	Sanitas Troesch	A	B	C
ND2.3111.	561 262	4722 210	1200	1000	80

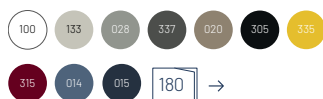
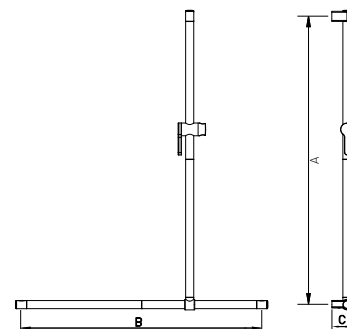

Duschhandlauf mit Brausestange Nylon, Brausestange glatte Oberfläche, mit Brausehalter, Brausestange verschiebbar

Barre d'appui d'angle avec glissière de douche Nylon, glissière surface tube lisse, avec support à rotule, barre verticale coulissante latérale

Corrimano ad angolo con asta per doccia Nylon, liscio, con supporto doccia, asta doccia scorrevole

Max. 175 kg

NOSAG	SGVSB Team	Sanitas Troesch	A	B	C
ND2.3112.xxx.L	561 263	4722 211	1200	750	750
ND2.3112.xxx.R	561 264	4722 212	1200	750	750
ND2.3113.xxx.L	561 265	4722 213	1200	950	950
ND2.3113.xxx.R	561 266	4722 214	1200	950	950



Abbildung in linker Ausführung (.L)
Image execution gauche (.L)
Immagine versione sinistra (.L)



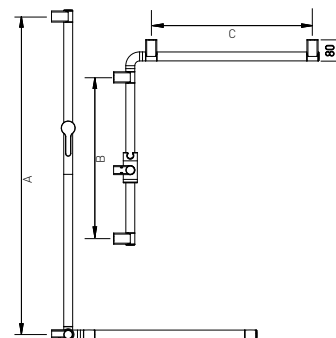
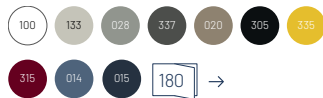

Duschhandlauf Nylon, mit glatter Oberfläche

Barre d'appui d'angle Nylon, tube lisse

Corrimano ad angolo Nylon, liscio

Max. 175 kg



NOSAG	SGVSB Team	Sanitas Troesch	A	B	C
ND2.3100.	561 261	4722 209	750	750	80
ND2.3101.			1000	1000	80

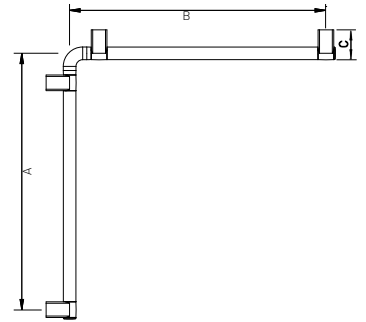

Brausehalter Nylon, d = 34 mm

Support à rotule Nylon, d = 34 mm

Supporto doccia Nylon, d = 34 mm

NOSAG	SGVSB Team	Sanitas Troesch	A	B	C
NDA.3110.	561 272	4722 220			

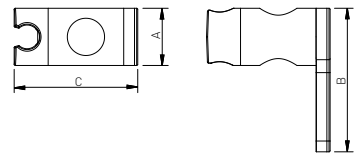



Duschklappsitz Nylon, mit Fallsicherung, für Wandmontage, weiss oder dunkelgrau

Siège de douche rabattable Nylon, avec frein de sécurité, montage mural, blanc ou gris foncé

Sedile ribaltabile Nylon, con freno di sicurezza, montaggio a muro, bianco o grigio scuro



NOSAG	SGVSB Team	Sanitas Troesch	A	B	C
ND3.3111.	585 633	4722 215	412	444	146

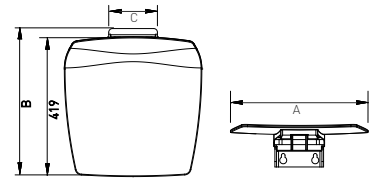

Montagesets | Sets de montage | Set di montaggio



für pour per	NOSAG	SGVSB Team	Sanitas Troesch
Lochziegelsteine Brique Mattone forato	NM1.0111.000	561 294	4722 200
Vorwandssysteme Murs préfabriqués Muri prefabbricati	NM1.0216.000	561 295	4722 201
Beton Béton Calcestruzzo	NM1.0308.000		



Duschklappsitz Nylon, mit Fallsicherung, für Wandmontage, mit geführter Bodenstütze, weiss oder dunkelgrau

Siège de douche rabattable Nylon, avec frein de sécurité, montage mural, avec pieds, blanc ou gris foncé

Sedile ribaltabile Nylon, con freno di sicurezza, montaggio a muro, con piede d'appoggio, bianco o grigio scuro

Max. 150 kg

NOSAG	SGVSB Team	Sanitas Troesch	A	B	C
ND3.3112.	561 268	4722 216	412	444	146

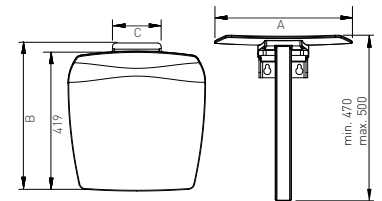

Montagesets | Sets de montage | Set di montaggio

für pour per	NOSAG	SGVSB Team	Sanitas Troesch
Lochziegelsteine Brique Mattone forato	NM1.0111.000	561 294	4722 200
Vorwandssysteme Murs préfabriqués Muri prefabbricati	NM1.0216.000	561 295	4722 201
Beton Béton Calcestruzzo	NM1.0308.000		



Duschvorhangstange L-Form Nylon, mit Vorhangringen, bauseits kürzbar, ohne Deckenabhängung

Tringle pour rideau de douche form L Nylon, avec anneaux pour rideau, peut être raccourci par le client, sans fixation pour plafond

Doccia bastone per tende Nylon, con tenda anelli, può essere accorciato sul luogo, senza supporto al plafone



NOSAG	SGVSB Team	Sanitas Troesch	A	B	C
ND5.3101.	561 269	4722 217	900	900	
ND5.3102.	561 270	4722 218	1000	1000	
ND5.3104.	561 271	4722 219	1200	1200	

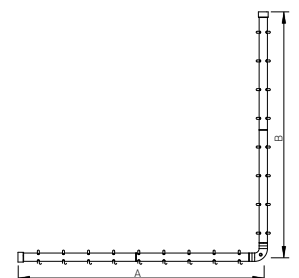



Deckenabhängung Nylon, bauseits kürzbar

Fixation pour plafond Nylon, peut être raccourci par le client

Supporto al plafone Nylon, può essere accorciato sul luogo

NOSAG	SGVSB Team	Sanitas Troesch	A	B	C
NDA.3805.	561 273	4722 221	500		



Duschvorhang für Vorhangstangen, 100% Polyester, mit Bleiband, bei 60° waschbar, antibakteriell, weiss mit Struktur

Rideau de douche Pour tringles pour rideau de douche, polyester 100%, avec ourlet plombé, lavable à 60°, antibactérien, blanc avec structure

Tenda per doccia Per aste da doccia, 100% poliestere, bordo con piombo, lavabile a 60°, antibatterico, bianco con struttura

NOSAG	SGVSB Team	Sanitas Troesch	A	B	C
NDA.5500.019		4721 890	2100	2000	
NDA.5501.019	585 630	4721 889	2400	2000	
NDA.5504.019		4721 888	2700	2000	

Mass mesure misura	Artikel article articolo	Ösen oeillets occhielli
2100 × 2000 mm	ND5.3101.	15
2400 × 2000 mm	ND5.3102.	16
2700 × 2000 mm	ND5.3104.	18

