

IneoLine Plus

Design Grip by NOSAG®



**Edelstahl, hochglanz poliert**

acier inoxydable, poli
acciaio inossidabile

**Edelstahl, matt gebürstet**

acier inoxydable, mat
acciaio inossidabile, opaco

Qualitätsmerkmale

Material

- Edelstahl 1.4301
- Rohrdurchmesser 37 mm
- Materialstärken 1.5 mm

Masse

- Wandabstand – Achse Rohr 64 mm
- Abdeckrosette D = 70 mm
- Montageflansch D = 60 mm

Alle Masse sind Achse – Achse gemessen (Ausnahme, die Duschhandläufe sind Achse – Wand gemessen)

→ Unsere Masszeichnungen finden Sie unter www.nosag.ch/download

Für Spezialanfertigungen bitte die Vorlagen für Massangaben auf unserer Internetseite benutzen.

Montage

- Bohrschablonen auf Anfrage erhältlich
- Alle Produkte werden mit verdeckter Montage geliefert
- Für alle klappbaren Produkte und die Stützgriffe muss das Montagematerial entsprechend des Mauerwerks bestellt werden. Bei den restlichen Produkten wird das Montagematerial mitgeliefert.

Alle abgebildeten Winkelgriffe und Duschhandläufe sind immer aus Sicht des Monteurs in der Ausführung links.

Signes de qualité

Matériaux

- acier inoxydable 1.4301
- diamètre 37 mm
- épaisseur du matériau 1.5 mm

Mesures

- distance du mur au tube 64 mm
- rosace D = 70 mm
- rosace perforée D = 60 mm

Toutes les dimensions sont mesurées d'axe en axe des tubes (exception: les barres d'appui d'angle sont mesurées axe-mur)

→ Vous trouvez nos plans sous www.nosag.ch/download

Pour toutes demandes de barre sur mesure, veuillez remplir le formulaire mis à disposition sur notre site

Montage

- Chablon de perçage sur demande.
- Tous les produits sont livrés avec montage invisible
- Pour les produits rabattables et barre d'appui mural les fixation au mur sont à définir suivant la nature du support. Pour les autres produits, le matériel de montage est fourni.

Toutes les images des barres d'appui d'angle sont des exécutions gauches du point de vue du monteur.

Caratteristiche qualitative

Materiale

- acier inoxydable 1.4301
- diamètre 37 mm
- épaisseur du matériau 1.5 mm

Misure

- Acciaio inossidabile 64 mm
- Diametro tubolare D = 70 mm
- Spessori del materiale D = 60 mm

Tutte le misure sono calcolate da asse ad asse (eccezione, i maniglioni per doccia sono misurati da asse a parete)

→ I nostri disegni tecnici quotati sono disponibili sul sito www.nosag.ch/download

Per realizzazioni su ordinazione utilizzare i modelli per l'indicazione delle misure disponibili sul nostro sito Internet

Montaggio

- Su richiesta sono disponibili dime per la foratura
- Tutti i prodotti vengono forniti con elementi di montaggio nascosti
- Per tutti i prodotti ribaltabili e le impugnature di supporto il materiale per il montaggio deve essere ordinato in base al tipo di muratura Per i prodotti restanti il materiale di fissaggio è incluso.

Tutti maniglioni angolari e i maniglioni per doccia sono raffigurati nella versione sinistra dal punto di vista dell'installatore



Haltegriff Edelstahl

Poignée d'appui Acier inoxydable

Corrimano Acciaio inossidabile

Max. 150 kg

NOSAG	SGVSB Team	Sanitas Troesch	A	B	C
LW0.0003.525*	585 120	4721 801	300		
LW0.0004.525*	585 121	4721 802	400		
LW0.0006.525*	585 122	4721 803	600		
LW0.0008.525*	585 123	4721 804	800		
LW0.0009.525*	585 124	4721 805	900		
LW0.0010.525*		4721 806	1000		
LW0.0011.525*		4721 807	1100		
LW0.0018.525*			1800		
LW0.0003.583**	585 120	4721 801	300		
LW0.0004.583**	585 121	4721 802	400		
LW0.0006.583**	585 122	4721 803	600		
LW0.0008.583**	585 123	4721 804	800		
LW0.0009.583**	585 124	4721 805	900		
LW0.0010.583**		4721 806	1000		
LW0.0011.583**		4721 807	1100		
LW0.0018.583**			1800		

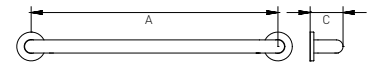

Haken Haken für WC-Bereich

Crochet Crochet pour WC

Gancio d'appoggio Gancio per WC

NOSAG	SGVSB Team	Sanitas Troesch	A	B	C
PDA.1730.501		4721 802	73	15	3
PDA.1730.337		4721 805	73	15	3





Abbildung in linker Ausführung (.L)
Illustration en version gauche (.L)
Illustrazione in versione sinistra (.L)

Winkelgriff Edelstahl

Poignée de sécurité Acier inoxydable

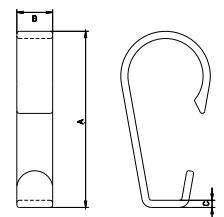
Corrimano ad angolo Acciaio inossidabile

Max. 150 kg

NOSAG	SGVSB Team	Sanitas Troesch	A	B	C
LW1.0033.525*		4721 815	305	305	80
LW1.0044.525*	585 101	4721 816	415	415	80
LW1.0033.583**		4721 815	305	305	80
LW1.0044.583**	585 101	4721 816	415	415	80



Abbildung in linker Ausführung (.L)
Illustration en version gauche (.L)
Illustrazione in versione sinistra (.L)

Winkelgriff Edelstahl

Poignée de sécurité Acier inoxydable

Corrimano ad angolo Acciaio inossidabile

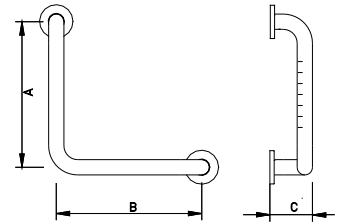
Max. 150 kg

NOSAG	SGVSB Team	Sanitas Troesch	A	B	C
LW1.0036.525.L*			610	305	80
LW1.0036.525.R*			610	305	80
LW1.0036.583.L**			610	305	80
LW1.0036.583.R**			610	305	80





Abbildung in linker Ausführung (.L)
Illustration en version gauche (.L)
Illustrazione in versione sinistra (.L)

Winkelgriff Edelstahl

Poignée de sécurité Acier inoxydable

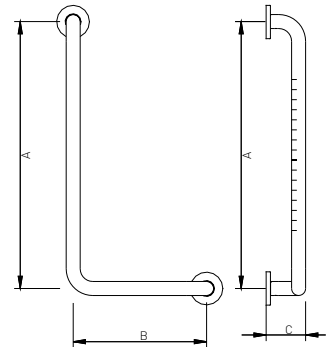
Corrimano ad angolo Acciaio inossidabile

Max. 150 kg

NOSAG	SGVSB Team	Sanitas Troesch	A	B	C
LW1.0048.525.L*	585 132	4721 821	815	405	80
LW1.0048.525.R*	585 133	4721 822	815	405	80
LW1.0059.525.L*	585 130	4721 819	950	500	80
LW1.0059.525.R*	585 131	4721 820	950	500	80
LW1.0048.583.L**	585 132	4721 821	815	405	80
LW1.0048.583.R**	585 133	4721 822	815	405	80
LW1.0059.583.L**	585 130	4721 819	950	500	80
LW1.0059.583.R**	585 131	4721 820	950	500	80

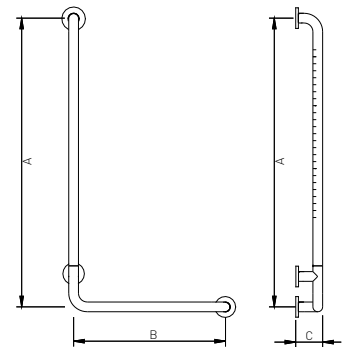

Stützklappgriff Edelstahl, mit Fallsicherung, MIT Montageplatte

Barre d'appui rabattable Acier inoxydable, avec frein de sécurité, AVEC plaque de montage

Corrimano ribaltabile Acciaio inossidabile, con freno di sicurezza, CON placca di montaggio

Max. 120 kg

NOSAG	SGVSB Team	Sanitas Troesch	A	B	C
LW2.0006.525*	585 317	4721 884	600	250	110
LW2.0007.525*	585 318	4721 885	720	250	110
LW2.0008.525*	585 319	4721 886	850	250	110
LW2.0006.583**	585 317	4721 884	600	250	110
LW2.0007.583**	585 318	4721 885	720	250	110
LW2.0008.583**	585 319	4721 886	850	250	110

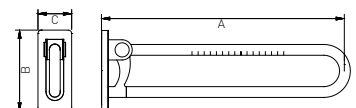

Montagesets | Sets de montage | Set di montaggio



	NOSAG	SGVSB Team	Sanitas Troesch
für pour per Lochziegelsteine brique matte forato	LM1.0100.000	585 390	4721 387
Leichtbauwand paroi léger parete divisoria leggera	LM1.0200.000	585 391	4721 388
Beton béton calcestruzzo	LM1.0300.000	585 392	



Stützklappgriff Edelstahl, mit Fallsicherung, zur fixen Montage, **OHNE Montageplatte**

Barre d'appui rabattable Acier inoxydable, avec frein de sécurité, pour montage fixe, **SANS plaque de montage**

Corrimano ribaltabile Acciaio inossidabile, con freno di sicurezza, per montaggio fisso, **SENZA placca di montaggio**

Max. 120 kg

NOSAG	SGVSB Team	Sanitas Troesch	A	B	C
LW2.0506.525			600	250	110
LW2.0506.583			720	250	110
LW2.0507.525			850	250	110
LW2.0507.583			600	250	110
LW2.0508.525			720	250	110
LW2.0508.583			850	250	110

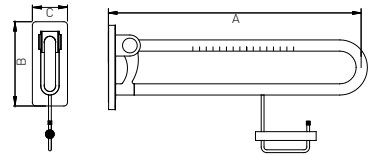

Stützklappgriff Edelstahl, mit Papierhalter,, mit Fallsicherung, **MIT Montageplatte**

Barre d'appui rabattable Acier inoxydable, avec porte-rouleau, avec frein de sécurité, **AVEC plaque de montage**

Corrimano ribaltabile Acciaio inossidabile, con portacarta, con freno di sicurezza, **CON placca di montaggio**

Max. 120 kg

NOSAG	SGVSB Team	Sanitas Troesch	A	B	C
LW2.0036.525*	585 320	4721 881	600	250	110
LW2.0037.525*	585 321	4721 882	720	250	110
LW2.0038.525*	585 322	4721 883	850	250	110
LW2.0036.583**	585 320	4721 881	600	250	110
LW2.0037.583**	585 321	4721 882	720	250	110
LW2.0038.583**	585 322	4721 883	850	250	110

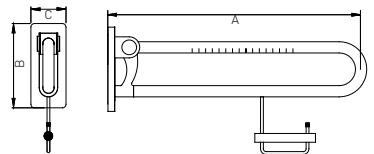

Montagesets | Sets de montage | Set di montaggio

für pour per	NOSAG	SGVSB Team	Sanitas Troesch
Lochziegelsteine brique matte forato	LM1.0100.000	585 390	4721 387
Leichtbauwand paroi léger parete divisoria leggera	LM1.0200.000	585 391	4721 388
Beton béton calcestruzzo	LM1.0300.000	585 392	



Montageplatte mit Abdeckung Edelstahl

Plaque de montage avec couvercle Acier inoxydable

Placca di montaggio con copertura Acciaio inossidabile

NOSAG	SGVSB Team	Sanitas Troesch	A	B	C
LWA.0033.525*	585 380	4721 899	239	106	17
LWA.0033.583**	585 380		239	106	17

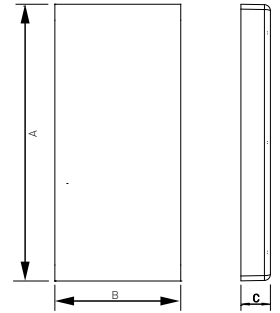

Montagesets | Sets de montage | Set di montaggio

für | pour | per

Lochziegelsteine

brique

mattone forato

Leichtbauwand

paroi léger

parete divisoria leggera

Beton

béton

calcestruzzo

NOSAG

LM1.0100.000

SGVSB Team

585 390

Sanitas Troesch

4721 387

LM1.0200.000

585 391

4721 388

LM1.0300.000

585 392



Stützklappgriff mit Fussstütze Edelstahl, mit Fallsicherung, mit Fussstütze, verstellbar

Barre d'appui rabattable avec support pied Acier inoxydable, avec frein de sécurité, avec support pied, réglable

Corrimano ribaltabile con supporto piede Acciaio inossidabile, con freno di sicurezza, con supporto piede, regolabile

Max. 170 kg

NOSAG	SGVSB Team	Sanitas Troesch	A	B	C
LW2.0016.525*			600	250	110
LW2.0017.525*			720	250	110
LW2.0018.525*			850	250	110
LW2.0016.583**			600	250	110
LW2.0017.583**			720	250	110
LW2.0018.583**			850	250	110

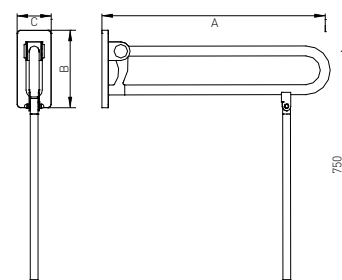

Montagesets | Sets de montage | Set di montaggio



für pour per	NOSAG	SGVSB Team	Sanitas Troesch
Lochziegelsteine brique mattone forato	LM1.0100.000	585 390	4721 387
Leichtbauwand paroi léger parete divisoria leggera	LM1.0200.000	585 391	4721 388
Beton béton calcestruzzo	LM1.0300.000	585 392	



Stützklappgriff Edelstahl, mit Fallsicherung, mit Standsäule für Bodenmontage, mit Montageset

Barre d'appui rabattable Acier inoxydable, avec frein de sécurité, avec support pour fixation au sol, avec set de montage

Corrimano ribaltabile Acciaio inossidabile, con freno di sicurezza, con colonna per frissaggio al pavimento, materiale di fissaggio

Max. 100 kg

NOSAG	SGVSB Team	Sanitas Troesch	A	B	C
LW2.0026.525*			600	792	740
LW2.0027.525*			720	792	740
LW2.0028.525*			850	792	740
LW2.0026.583**			600	792	740
LW2.0027.583**			720	792	740
LW2.0028.583**			850	792	740

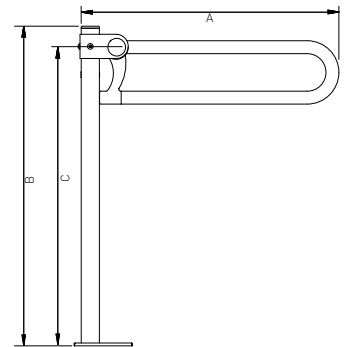

Papierrollenhalter Edelstahl, mit Blattstopper

Dérouleur papier WC Acier inoxydable, avec butée

Portarotolo WC Acciaio inossidabile, con fermacarta

NOSAG	SGVSB Team	Sanitas Troesch	A	B	C
LWA.1111.525*			132	146	86
LWA.1111.583**			132	146	86

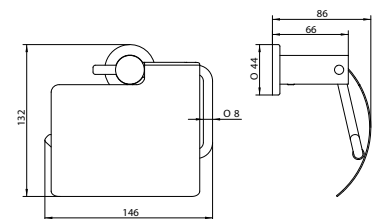

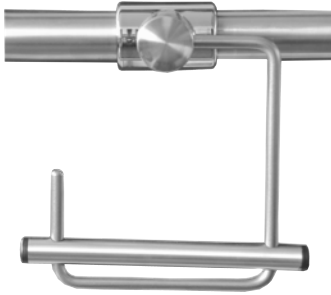

Papierrollenhalter Edelstahl, zum Anklemmen
Dérouleur papier WC Acier inoxydable, à clipser
Portarotolo WC Acciaio inossidabile, da agganciare

NOSAG	SGVSB Team	Sanitas Troesch	A	B	C
LWA.1102.525*	585 345				
LWA.1102.583**	585 345				

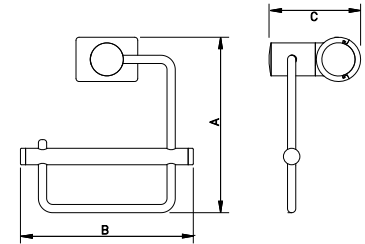

Rückenstütze Edelstahl, mit Rückenkissen, schwarz
Appui-dos Acier inoxydable, avec coussin dossier, noir
Schienale di sostegno Acciaio inossidabile, con cuscino schienale, nero

NOSAG	SGVSB Team	Sanitas Troesch	A	B	C
LWA.1410.525*	585 420	4721 399	530	400	200
LWA.1410.583**	585 420	4721 399	530	400	200

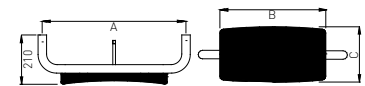

Ersatzrollenhalter Edelstahl, für 1 Rolle
Dérouleur papier de réserve Acier inoxydable, pour 1 rouleau
Portarotolo di scorta Acciaio inossidabile, per 1 rotolo

NOSAG	SGVSB Team	Sanitas Troesch	A	B	C
LWA.1211.525*			170	80	54
LWA.1211.583**			170	80	54

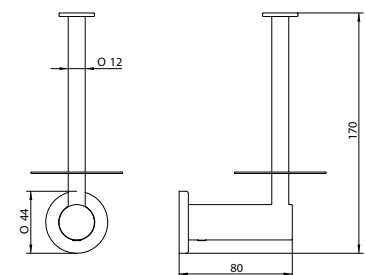



Ersatzrollenhalter Edelstahl, für 2 Rollen

Dérouleur papier de réserve Acier inoxydable, pour 2 rouleaux

Portarotolo di scorta Acciaio inossidabile, per 2 rotoli

NOSAG	SGVSB Team	Sanitas Troesch	A	B	C
LWA.1212.525*			300	80	54
LWA.1212.583**			300	80	54

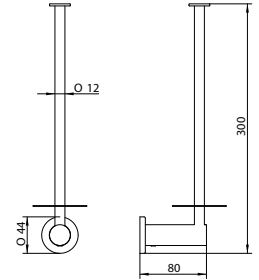

Bürstengarnitur Edelstahl, für Wandmontage

Ensemble brosse WC Acier inoxydable, pour montage mural

Portaspazzola WC Acciaio inossidabile, per montaggio a parete

NOSAG	SGVSB Team	Sanitas Troesch	A	B	C
LWA.1312.525*			360	118	90
LWA.1312.583**			360	118	90

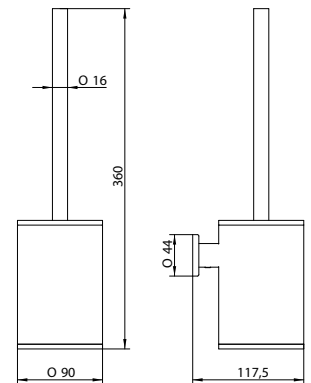



Piktogramm | Pictogramme | Pittogramma



Männliche Person Edelstahl, matt gebürstet, männliche Person

Personne homme Acier inoxydable, mat, personnage masculin

Persona uomo Acciaio inossidabile, opaco, bagno uomini

NOSAG	SGVSB Team	Sanitas Troesch	A	B	C
NWA.1710.583		4721 691	125	125	



Weibliche Person Edelstahl, matt gebürstet, weibliche Person

Personne femme Acier inoxydable, mat, personnage féminin

Persona donna Acciaio inossidabile, bagno donne

NOSAG	SGVSB Team	Sanitas Troesch	A	B	C
NWA.1711.583		4721 692	125	125	



IV-WC Edelstahl, matt gebürstet, IV-WC

WC accessible Acier inoxydable, mat, toilette pour handicapés

WC accessibile Acciaio inossidabile, opaco, bagno handicap

NOSAG	SGVSB Team	Sanitas Troesch	A	B	C
NWA.1712.583		4721 693	125	125	



Hygiene-Abfallbehälter Edelstahl, Wandmontage, 4,5 Liter

Poubelle hygiénique Acier inoxydable, montage mural, 4,5 litre

Contentore rifiuti per salviette igieniche Acciaio inossidabile, montaggio a muro, 4,5 litri

NOSAG	SGVSB Team	Sanitas Troesch	A	B	C
MWA.1400.525*	585 058		260	225	100
MWA.1400.583**	585 058		260	225	100

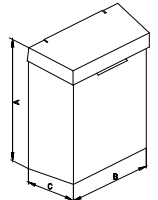

Hygienebeutelspender Edelstahl

Distributeur de sachets hygiéniques Acier inoxydable

Distributore di sacchetti igiene Acciaio inossidabile

NOSAG	SGVSB Team	Sanitas Troesch	A	B	C
MWA.1500.525*	585 057		170	95	24
MWA.1500.583**	585 057		170	95	24

Dazugehöriger Artikel | Article correspondant | Articoli correlati

Hygienebeutel (30 Stk.)

MWV.TAA901.000

Sachets hygiéniques (30 pcs.)

Sacchetti igienici (30 pz.)

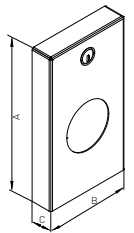

Abfallbehälter mit integriertem Hygienebeutelspender Edelstahl, Wandmontage, 4,5 Liter, Diebstahlsicher

Poubelle murale avec distributeur de sachets hygiéniques intégré Acier inoxydable, montage mural, 4,5 litre, Antivol

Contentore rifiuti con distributore sacchi igienici integrato Acciaio inossidabile, montaggio a muro, 4,5 litri, a prova di furto

NOSAG	SGVSB Team	Sanitas Troesch	A	B	C
MWA.1510.525*	585 056	4721 103	260	225	100
MWA.1510.583**	585 056	4721 103	260	225	100

Dazugehöriger Artikel | Article correspondant | Articoli correlati

Hygienebeutel (30 Stk.)

MWV.TAA901.000

Sachets hygiéniques (30 pcs.)

Sacchetti igienici (30 pz.)

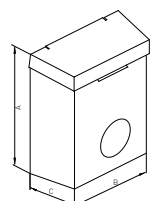



Brausestange Edelstahl, mit Brausehalter

Barre de douche Acier inoxydable, avec support à douche

Asta doccia Acciaio inossidabile, con supporto doccia

Max. 150 kg

NOSAG	SGVSB Team	Sanitas Troesch	A	B	C
LD0.0008.525*	585 135	4721 835	800		80
LD0.0009.525*			900		80
LD0.0010.525*	585 136	4721 837	1000		80
LD0.0011.525*	585 137	4721 838	1100		80
LD0.0012.525*			1200		80
LD0.0008.583**	585 135	4721 835	800		80
LD0.0009.583**			900		80
LD0.0010.583**	585 136	4721 837	1000		80
LD0.0011.583**	585 137	4721 838	1100		80
LD0.0012.583**			1200		80

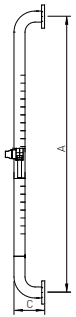

Winkelgriff mit Brausestange Edelstahl, mit Brausehalter

Barre d'angle avec barre de douche Acier inoxydable, avec support à douche

Corrimano angolare con asta doccia Acciaio inossidabile, con supporto doccia

Max. 150 kg

NOSAG	SGVSB Team	Sanitas Troesch	A	B	C
LD1.0051.525.L*	585 138	4721 831	1200	500	80
LD1.0051.525.R*	585 139	4721 832	1200	500	80
LD1.0061.525.L*			1200	600	80
LD1.0061.525.R*			1200	600	80
LD1.0051.583.L**	585 138	4721 831	1200	500	80
LD1.0051.583.R**	585 139	4721 832	1200	500	80
LD1.0061.583.L**			1200	600	80
LD1.0061.583.R**			1200	600	80



Abbildung in linker Ausführung (.L)
Illustration en version gauche (.L)
Illustrazione in versione sinistra (.L)



Duschhandlauf T-Form Edelstahl, mit Brausehalter, Brausestange verschiebbar

Main courante de douche en T Acier inoxydable, avec support de douche, barre de douche réglable

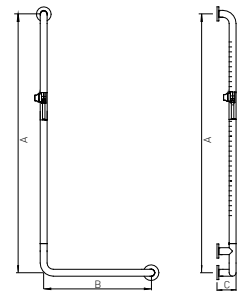
Corrimano doccia a T Acciaio inossidabile, con supporto doccia, asta doccia regolabile

Max. 120 kg

NOSAG	SGVSB Team	Sanitas Troesch	A	B	C
LD1.0061.525*	585 172	4721 845	1200	600	80
LD1.0081.525*		4721 846	1200	800	80
LD1.0061.583**	585 172	4721 845	1200	600	80
LD1.0081.583**		4721 846	1200	800	80

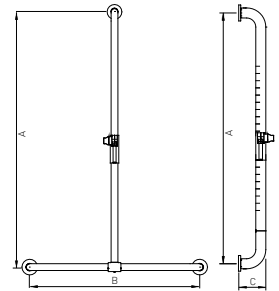

Duschhandlauf Edelstahl

Barre d'appui d'angle Acier inoxydable

Corrimano ad angolo Acciaio inossidabile

Max. 150 kg

NOSAG	SGVSB Team	Sanitas Troesch	A	B	C
LD2.0002.525*		4721 841	763	763	80
LD2.0002.583**		4721 841	763	763	80

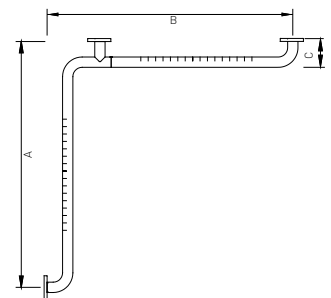



Abbildung in linker Ausführung (.L)
Illustration en version gauche (.L)
Illustrazione in versione sinistra (.L)

Duschhandlauf mit Brausestange Edelstahl, mit Brausehalter

Main courante de douche avec barre de douche Acier inoxydable, avec support à douche

Corrimano doccia con asta doccia Acciaio inossidabile, con supporto doccia

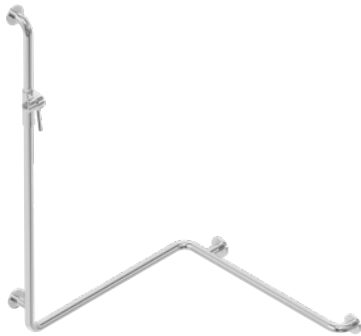
Max. 150 kg

NOSAG	SGVSB Team	Sanitas Troesch	A	B	C
LD2.0102.525.L*	585 142	4721 833	1200	763	763
LD2.0102.525.R*	585 143	4721 834	1200	763	763
LD2.0102.583.L**	585 142	4721 833	1200	763	763
LD2.0102.583.R**	585 143	4721 834	1200	763	763

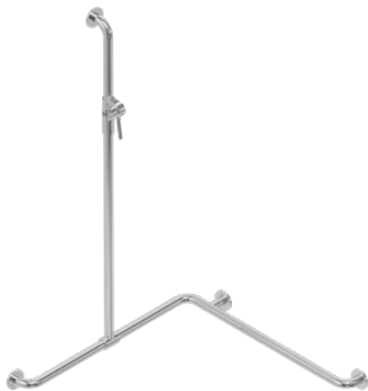
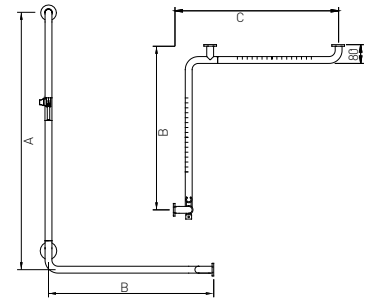

Duschhandlauf mit Brausestange (verschiebbar) Edelstahl, mit Brausehalter, Brausestange verschiebbar

Main courante de douche avec barre de douche réglable Acier inoxydable, avec support à douche, barre de douche réglable

Corrimano doccia con asta doccia regolabile Acciaio inossidabile, con supporto doccia, asta doccia regolabile

Max. 150 kg

NOSAG	SGVSB Team	Sanitas Troesch	A	B	C
LD2.0202.525*	585 141	4721 830	1200	763	763
LD2.0202.583**	585 141	4721 830	1200	763	763

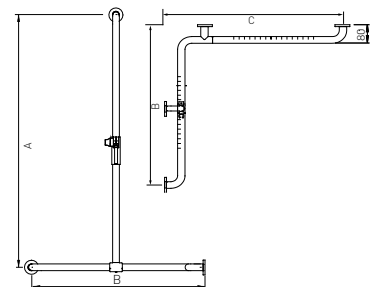

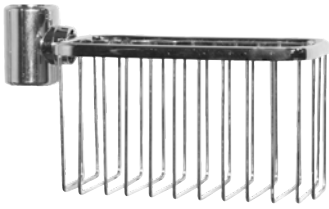

Duschablage Edelstahl, zum Anklemmen

Tablette de douche Acier inoxydable, à accrocher

Mensola doccia Acciaio inossidabile, da appendere

NOSAG	SGVSB Team	Sanitas Troesch	A	B	C
LDA.1125.525*	585 125	4721 847	200	100	80
LDA.1125.583**	585 125	4721 847	200	100	80

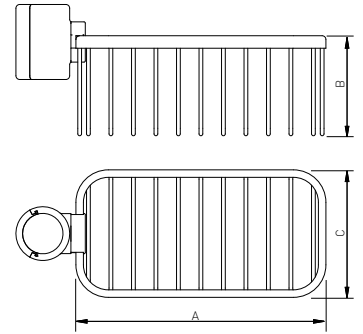

Brausehalter Edelstahl, d = 32 mm

Support de douche Acier inoxydable, d = 32 mm

Supporto doccia Acciaio inossidabile, d = 32 mm

NOSAG	SGVSB Team	Sanitas Troesch	A	B	C
LDA.1101.525*	585 119		32		
LDA.1101.583**	585 119		32		

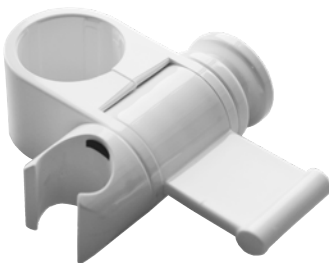
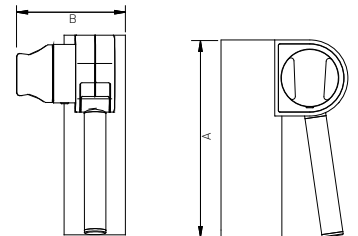

Brausehalter Nylon, d = 32 mm

Support de douche Nylon, d = 32 mm

Supporto doccia Nylon, d = 32 mm

NOSAG	SGVSB Team	Sanitas Troesch	A	B	C
NDA.4000.	585 116		112	34	90

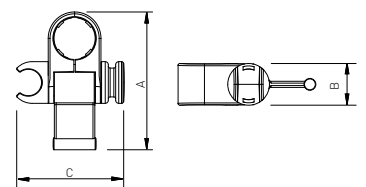

180 →



Duschklappsitz Edelstahl, mit Fallsicherung, für Wandmontage, Kunststoffmodul weiss

Siège de douche rabattable Acier inoxydable, avec frein de sécurité, montage mural, siège blanc

Sedile ribaltabile da doccia Acciaio inossidabile, con freno di sicurezza, montaggio a muro, modulo in plastica bianca

Max. 150 kg

NOSAG	SGVSB Team	Sanitas Troesch	A	B	C
FD3.1000.525*			482	355	133
FD3.1000.583**			482	355	133

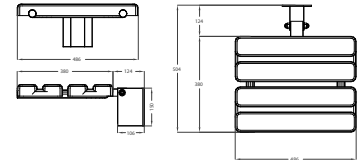

Montagesets | Sets de montage | Set di montaggio

für | pour | per

Lochziegelsteine

brique

mattone forato

Leichtbauwand

paroi léger

parete divisoria leggera

Beton

béton

calcestruzzo

NOSAG

LM1.0100.000

SGVSB Team

585 390

Sanitas Troesch

4721 387

LM1.0200.000

585 391

4721 388

LM1.0300.000

585 392

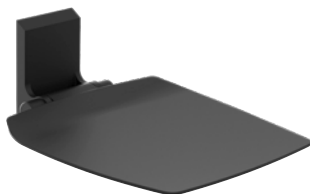

Duschklappsitz Aluminium, für Wandmontage, mit Fallsicherung, **MIT Montageplatte**

Siège de douche rabattable Aluminium, montage mural, avec frein de sécurité, **AVEC plaque de montage**

Sedile ribaltabile da doccia Alluminio, montaggio a muro, con freno di sicurezza, **CON placca di montaggio**

Max. 150 kg

NOSAG	SGVSB Team	Sanitas Troesch	A	B	C
ND3.6170.	585 616	4721 785	412	419	512
ND3.6171.			412	422	512

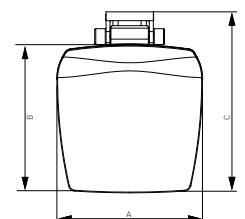



Duschklapsitz Aluminium, mit Armlehnen, für Wandmontage, mit Fallsicherung, **MIT Montageplatte**

Siège de douche rabattable Aluminium, avec accoudoirs, montage mural, avec frein de sécurité, **AVEC plaque de montage**

Sedile ribaltabile da doccia Alluminio, con braccioli, montaggio a muro, con freno di sicurezza, **CON placca di montaggio**

Max. 150 kg

NOSAG	SGVSB Team	Sanitas Troesch	A	B	C
ND3.6172.			412	422	512

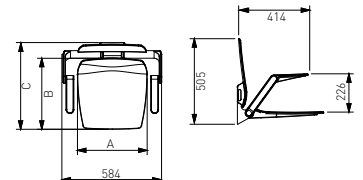

Montagesets | Sets de montage | Set di montaggio

für pour per	NOSAG	SGVSB Team	Sanitas Troesch
für Lochziegelsteine pour brique per mattone forato	NM1.0106.000	585 580	4721 795
für Leichtbauwand pour paroi léger per parete divisoria leggera	NM1.0206.000	585 581	4721 796
für Beton pour béton per calcestruzzo	NM1.0306.000	585 599	4721 798



Duschklapsitz Edelstahl, mit Fallsicherung, für Wandmontage, mit weichem Polster, grau

Siège de douche rabattable Acier inoxydable, montage mural, avec frein de sécurité, coussin doux gris, avec échancrure, avant ouvert

Sedile ribaltabile da doccia Acciaio inossidabile, con freno di sicurezza, montaggio a muro, con sedile imbottito morbido, grigio

Max. 120 kg

NOSAG	SGVSB Team	Sanitas Troesch	A	B	C
FD3.1100.525.A*			460	410	130
FD3.1100.583.A**			460	410	130

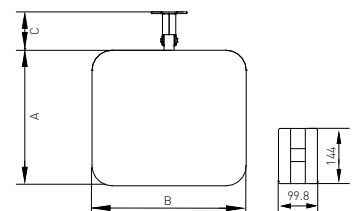



Variante mit Bodenstütze

Variante avec pieds suppl.

Varianta con piedi d'appoggio

Max. 150 kg

NOSAG	SGVSB Team	Sanitas Troesch	A	B	C
FD3.1110.525.A*			460	410	130
FD3.1110.583.A**			460	410	130

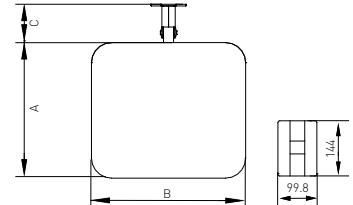

Montagesets | Sets de montage | Set di montaggio



für pour per	NOSAG	SGVSB Team	Sanitas Troesch
Lochziegelsteine brique mattone forato	LM1.0100.000	585 390	4721 387
Leichtbauwand paroi léger parete divisoria leggera	LM1.0200.000	585 391	4721 388
Beton béton calcestruzzo	LM1.0300.000	585 392	



Duschklapsitz Edelstahl, Wandmontage,, mit Fallsicherung, weiches Polster grau, mit Hygieneausschnitt vorne offen

Siège de douche rabattable Acier inoxydable, montage mural, avec frein de sécurité, coussin doux gris, avec échancrure avant ouvert

Sedile ribaltabile da doccia Acciaio inossidabile, montaggio a muro, con freno di sicurezza, cuscino morbido grigio, con nicchia igiene anteriore aperto

Max. 120 kg

NOSAG	SGVSB Team	Sanitas Troesch	A	B	C
FD3.1101.525.A*			460	410	130
FD3.1101.583.A**			460	410	130

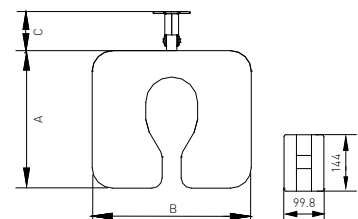



Variante mit Bodenstütze

Variante avec pieds suppl.

Varianta con piedi d'appoggio

Max. 150 kg

NOSAG	SGVSB Team	Sanitas Troesch	A	B	C
FD3.1111.525.A*			460	410	130
FD3.1111.583.A**			460	410	130

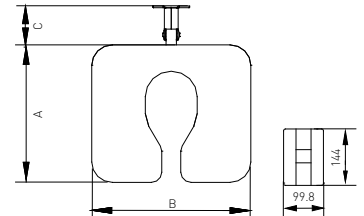

Montagesets | Sets de montage | Set di montaggio

für | pour | per

Lochziegelsteine

brique

mattoni forati

Leichtbauwand

paroi légère

parete divisoria leggera

Beton

béton

calcestruzzo

NOSAG

LM1.0100.000

SGVSB Team

585 390

Sanitas Troesch

4721 387

LM1.0200.000

585 391

4721 388

LM1.0300.000

585 392



Duschklappsitz Edelstahl, mit Fallsicherung, für Wandmontage, mit weichem Polster, grau, mit Hygieneausschnitt vorn geschlossen

Siège de douche rabattable Acier inoxydable, avec frein de sécurité, montage mural, rembourrage gris, enclanchement, fermé devant

Sedile ribaltabile da doccia Acciaio inossidabile, con freno di sicurezza, montaggio a muro, sedile imbottito morbido, grigio, apertura d'igiene, fronte aperta

Max. 120 kg

NOSAG	SGVSB Team	Sanitas Troesch	A	B	C
FD3.1102.525.A*			460	410	130
FD3.1102.583.A**			460	410	130

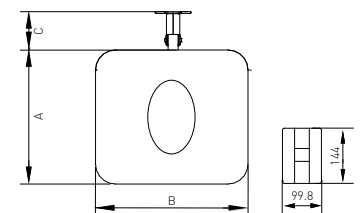



Variante mit Bodenstütze

Variante avec pieds suppl.

Varianta con piedi d'appoggio

Max. 150 kg

NOSAG	SGVSB Team	Sanitas Troesch	A	B	C
FD3.1112.525.A*			460	410	130
FD3.1112.583.A**			460	410	130

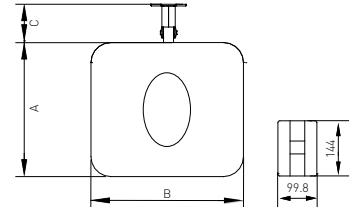

Montagesets | Sets de montage | Set di montaggio



für pour per	NOSAG	SGVSB Team	Sanitas Troesch
Lochziegelsteine brique mattone forato	LM1.0100.000	585 390	4721 387
Leichtbauwand paroi léger parete divisoria leggera	LM1.0200.000	585 391	4721 388
Beton béton calcestruzzo	LM1.0300.000	585 392	

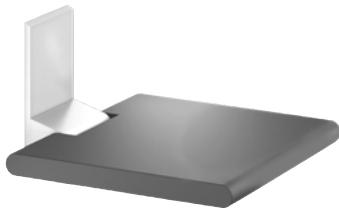

Duschklapsitz Aluminium verchromt, für Wandmontage,, mit Fallsicherung, **MIT Montageplatte**,
Polster anthrazit

Siège de douche rabattable Polster anthrazit Aluminium chromé, montage mural, avec frein de
sécurité, **AVEC plaque de montage**, rembourrage anthracite

Sedile ribaltabile da doccia Alluminio cromato, montaggio a muro, con freno di sicurezza, **CON placca
di montaggio**, sedile imbottito antracite

Max. 150 kg

NOSAG	SGVSB Team	Sanitas Troesch	A	B	C
ND3.6101.501	585 046	4721 751	380	462	
ND3.6102.501	585 047		450	462	

Aluminium für Wandmontage,, mit Fallsicherung, **OHNE Montageplatte**, Polster anthrazit

Aluminium, montage mural, avec frein de sécurité, **SANS plaque de montage**, rembourrage anthracite

Alluminio, muro montaggio, con freno di sicurezza, **SENZA placca di montaggio**, sedile imbottito
antracite

Max. 150 kg

NOSAG	SGVSB Team	Sanitas Troesch	A	B	C
ND3.6101.	585 612	4721 751	380	462	
ND3.6102.	585 613	4721 752	450	462	

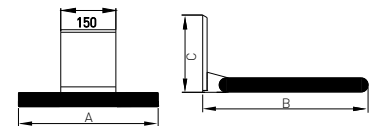

Montagesets | Sets de montage | Set di montaggio

für pour per	NOSAG	SGVSB Team	Sanitas Troesch
Lochziegelsteine brique mattoni forati	NM1.0106.000	585 580	4721 795
Leichtbauwand paroi légère parete divisoria leggera	NM1.0206.000	585 581	4721 796
Beton béton calcestruzzo	NM1.0306.000	585 599	4721 798

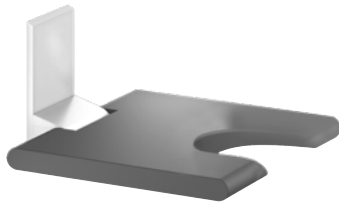

Duschklappsitz Aluminium verchromt, mit Hygieneausschnitt, für Wandmontage, mit Fallsicherung, **MIT Montageplatte**, Polster anthrazit

Siège de douche rabattable Aluminium chromé, avec échancrure, montage mural, avec frein de sécurité, **AVEC plaque de montage**, rembourrage anthracite

Sedile ribaltabile da doccia Alluminio cromato, con nicchia igiene, montaggio a muro, con freno di sicurezza, **CON placca di montaggio**, sedile imbottito antracite

Max. 150 kg

NOSAG	SGVSB Team	Sanitas Troesch	A	B	C
ND3.6102.501.A			450	462	

Aluminium, mit Hygieneausschnitt, für Wandmontage, mit Fallsicherung, **MIT Montageplatte**, Polster anthrazit

Aluminium, avec échancrure, montage mural, avec frein de sécurité, **AVEC plaque de montage**, rembourrage anthracite

Alluminio, con nicchia igiene, montaggio a muro, con freno di sicurezza, **CON placca di montaggio**, sedile imbottito antracite

Max. 150 kg

NOSAG	SGVSB Team	Sanitas Troesch	A	B	C
ND3.6102.-.A			450	462	

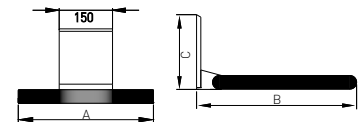

Montagesets | Sets de montage | Set di montaggio

für pour per	NOSAG	SGVSB Team	Sanitas Troesch
Lochziegelsteine brique mattone forato	NM1.0106.000	585 580	4721 795
Leichtbauwand paroi léger parete divisoria leggera	NM1.0206.000	585 581	4721 796
Beton béton calcestruzzo	NM1.0306.000	585 599	4721 798



Montageplatte mit Abdeckung Aluminium

Plaque de montage avec couvercle Aluminium

Placca di montaggio con copertura Alluminio

NOSAG	SGVSB Team	Sanitas Troesch	A	B	C
NWA.6013.	585 589	4721 779	220	100	22

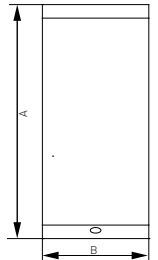

Montagesets | Sets de montage | Set di montaggio

für | pour | per

Lochziegelsteine

brique

mattone forato

Leichtbauwand

paroi léger

parete divisoria leggera

Beton

béton

calcestruzzo

NOSAG

NM1.0106.000

SGVSB Team

585 580

Sanitas Troesch

4721 795

NM1.0206.000

585 581

4721 796

NM1.0306.000

585 599

4721 798



Rückenkissen Edelstahl, für Wandmontage, mit weichem Polster grau

Coussin de dossier Acier inoxydable, pour montage mural, avec coussin doux gris

Cuscino schienale Acciaio inossidabile, per montaggio a muro, con cuscino morbido grigio

NOSAG	SGVSB Team	Sanitas Troesch	A	B	C
FDA.1410.339			445	195	

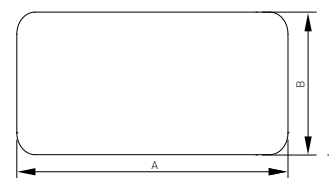



Duschklappsitz zum Einhängen Edelstahl, mit Fallsicherung, zum Einhängen auf 2 Höhen, mit weichem Polster grau

Siège de douche rabattable, à suspendre Acier inoxydable, frein de sécurité, à suspendre avec hauteurs variables, avec rembourrage gris

Sedile ribaltabile da doccia, per appendere Acciaio inossidabile, con freno di sicurezza, per appendere su 2 altezze, con imbottito morbida grigio

Max. 120 kg

NOSAG	SGVSB Team	Sanitas Troesch	A	B	C
FD3.1500.525*			460	405	210
FD3.1500.583**			460	405	210

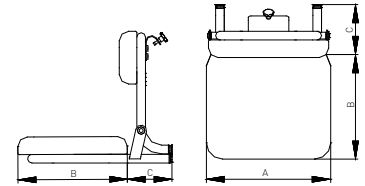

Duschklappsitz zum Einhängen Edelstahl, mit Fallsicherung, zum Einhängen auf 2 Höhen, mit weichem Polster grau, mit Hygieneausschnitt vorn offen

Siège de douche rabattable, à suspendre Acier inoxydable, frein de sécurité, à suspendre avec hauteurs variables, avec rembourrage gris, enclanchure, ouvert devant

Sedile ribaltabile da doccia, per appendere Acciaio inossidabile, con freno di sicurezza, per appendere su 2 altezze, con imbottito morbida grigio, con piedi d'appoggio

Max. 120 kg

NOSAG	SGVSB Team	Sanitas Troesch	A	B	C
FD3.1501.525.A*			460	405	210
FD3.1501.583.A**			460	405	210

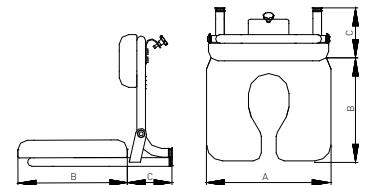



Duschklapsitz zum Einhängen Edelstahl, mit Fallsicherung, einstellbar auf 2 Höhen, mit weichem Polster grau, mit Hygieneausschnitt vorn geschlossen

Siège de douche rabattable à suspendre Acier inoxydable, avec frein de sécurité, réglable sur 2 hauteurs, avec rembourrage gris, enclenchure, fermé devant

Sedile ribaltabile da doccia per appendere Acciaio inossidabile, con freno di sicurezza, regolabile a 2 altezze, con imbottito morbida grigio, con piedi d'appoggio

Max. 120 kg

NOSAG	SGVSB Team	Sanitas Troesch	A	B	C
FD3.1502.525.A*			460	405	210
FD3.1502.583.A**			460	405	210

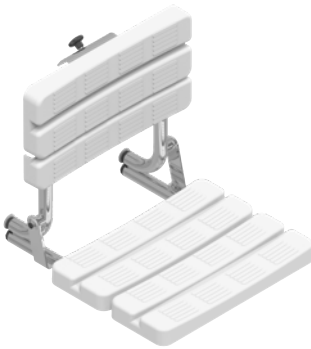
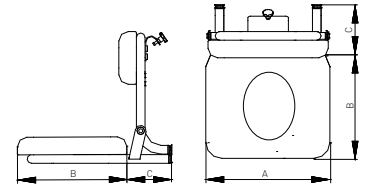

Duschklapsitz zum Einhängen Edelstahl, mit Fallsicherung, einstellbar auf 2 Höhen, mit Kunststoffmodul weiss

Siège de douche rabattable à suspendre Acier inoxydable, avec frein de sécurité, réglable sur 2 hauteurs, siège blanc

Sedile ribaltabile da doccia per appendere Acciaio inossidabile, con freno di sicurezza, regolabile a 2 altezze, modulo in plastica bianco

Max. 150 kg

NOSAG	SGVSB Team	Sanitas Troesch	A	B	C
FD3.1400.525*		4721 398	482	364	533
FD3.1400.583**		4721 398	482	364	533

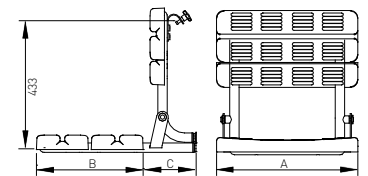

Duschklapsitz Cavere für Rundrohr Aluminium (Farbskala siehe Seite 228), mit Fallsicherung, Polster anthrazit

Siège de douche Cavere pour tube rond Aluminium (gamme de couleurs voir la page 228), avec frein de sécurité, rembourrage noir

Sedile doccia Cavere per tubo tondo Alluminio (gamma di colori vedere pagina 228), con freno di sicurezza, sedile imbottito antracite

Max. 150 kg

NOSAG	SGVSB Team	Sanitas Troesch	A	B	C
ND3.6600.	585 410	4721 853	380	563	340
ND3.6610.	585 418	4721 854	450	563	340

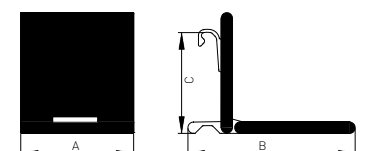

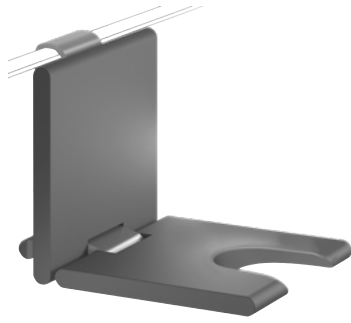

Duschklapsitz Cavere für Rundrohr zum Einhängen Aluminium,, mit Fallsicherung, mit Hygieneausschnitt, Polster anthrazit

Siège de douche Cavere pour tube rond à suspendre Aluminium, avec frein de sécurité, avec échancrure, rembourrage noir

Sedile doccia Cavere per tubo tondo per appendere Alluminio, con freno di sicurezza, sedile imbottito, con nicchia igiene antracite

Max. 150 kg

NOSAG	SGVSB Team	Sanitas Troesch	A	B	C
ND3.6610.-A			450	563	

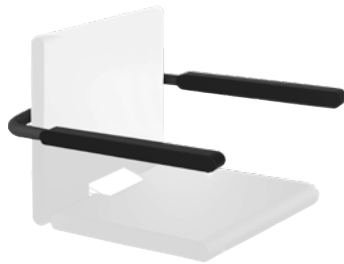
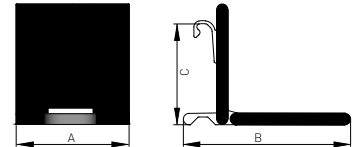

Armlehnen Aluminium, nachrüstbar zu Duschklapsitzen Cavere einhängbar, hochklappbar

Accoudoirs Aluminium, à monter sur siège Cavere à suspendre, repliable

Braccioli Alluminio, attrezzatura per sedile ribaltabile d'appendere Cavere, può essere ripiegato

NOSAG	SGVSB Team	Sanitas Troesch	A	B	C
NDA.6301.	585 622	4721 760	590	509	

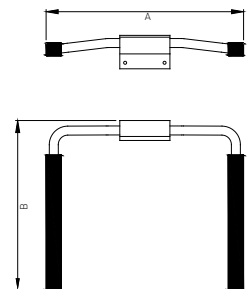

Duschklapsitz Cavere für Rundrohr zum Einhängen Aluminium, Duschklapsitz komplett anthrazit oder weiss,, mit Fallsicherung

Siège de douche Cavere pour tube rond à suspendre Aluminium, siège de douche rabattable complètement anthracite ou blanc, avec frein de sécurité

Sedile doccia Cavere per tubo tondo per appendere Alluminio, sedile ribaltabile completamente antracite o bianco, con freno di sicurezza

Max. 150 kg

NOSAG	SGVSB Team	Sanitas Troesch	A	B	C
ND3.3581.	585 619	4721 685	412	422	642

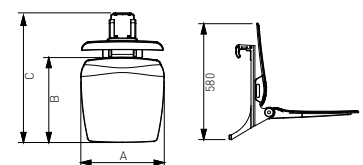



Duschklappsitz Cavere für Rundrohr zum Einhängen Aluminium, Duschklappsitz komplett anthrazit oder weiss,, mit Fallsicherung, mit Armlehnen

Siège de douche Cavere pour tube rond à suspendre Aluminium, siège de douche rabattable complètement anthracite ou blanc, avec frein de sécurité, avec accoudoirs

Sedile doccia Cavere per tubo tondo per appendere Alluminio, sedile ribaltabile completamente antracite o bianco, con freno di sicurezza, con braccioli

Max. 150 kg

NOSAG	SGVSB Team	Sanitas Troesch	A	B	C
ND3.3582.	585 623	4721 686	412	422	642

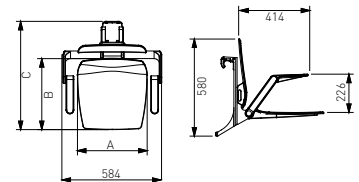

Duschvorhangstange gerade Edelstahl, d = 22 mm, mit Vorhangringen Nylon weiss, bauseits kürzbar

Tringle droite pour rideau de douche Acier inoxydable, d = 22 mm, avec anneaux pour rideau nylon blanc, peut être raccourci par le client

Doccia bastone per tende Acciaio inossidabile, d = 22 mm, tenda anelli Nylon bianco, può essere accorciato sul luogo

NOSAG	SGVSB Team	Sanitas Troesch	A	B	C
LD5.1008.525*	171 541		800		
LD5.1009.525*	171 546		900		
LD5.1010.525*	171 547		1000		
LD5.1011.525*	171 548		1100		
LD5.1019.525*			1900		
LD5.1008.583**	171 541		800		
LD5.1009.583**	171 546		900		
LD5.1010.583**	171 547		1000		
LD5.1011.583**	171 548		1100		
LD5.1019.583**			1900		

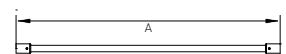



Duschvorhangstange L-Form Edelstahl, d = 22 mm, mit Vorhangringen, Nylon weiss, bauseits kürzbar, ohne Deckenabhangung

Tringle de rideau de douche en L Acier inoxydable, d = 22 mm, avec anneaux pour rideau nylon blanc, peut être raccourci par le client, sans fixation pour plafond

Asta per tenda doccia a L Acciaio inossidabile, d = 22 mm, tenda anelli Nylon bianco, può essere accorciato sul luogo, senza supporto al plafone

NOSAG	SGVSB Team	Sanitas Troesch	A	B	C
LD5.1100.525*	171 549	4721 891	900	900	
LD5.1191.525*	171 543	4721 893	900	1100	
LD5.1101.525*	171 551	4721 892	1000	1000	
LD5.1112.525*			1000	1200	
LD5.1102.525*	171 550		1100	1100	
LD5.1103.525*	171 542	4721 894	1200	1200	
LD5.1104.525*			1500	1500	
LD5.1100.583**	171 549	4721 891	900	900	
LD5.1191.583**	171 543	4721 893	900	1100	
LD5.1101.583**	171 551	4721 892	1000	1000	
LD5.1112.583**			1000	1200	
LD5.1102.583**	171 550		1100	1100	
LD5.1103.583**	171 542	4721 894	1200	1200	
LD5.1104.583**			1500	1500	

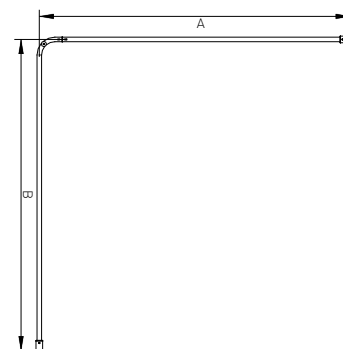



Duschvorhang 100% Polyester, waschbar 60°, antibakteriell, weiss mit Struktur

Rideau de douche 100% polyester, lavable 60°, antibactérien, blanc avec structure

Tenda per doccia 100% poliestere, lavabile 60°, antibatterico, bianco con struttura

NOSAG	SGVSB Team	Sanitas Troesch	A	B	C
NDA.5511.019			1200	2000	
NDA.5501.019	585 630	4721 889	2400	2000	
NDA.5502.019	585 631		3000	2000	

Mass mesure misura	Artikel article articolo	Ösen oeillets occhielli
1200 × 2000 mm	LD5.1100, LD5.1191	9
2400 × 2000 mm	LD5.1100, LD5.1191	16
3000 × 2000 mm	LD5.1103, LD5.1112	20

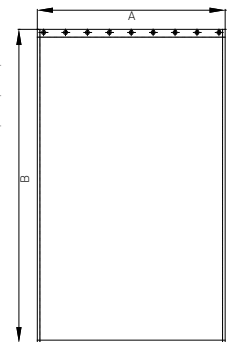

Deckenabhängung Edelstahl, bauseits kürzbar

Fixation pour plafond Acier inoxydable, recoupable sur place

Supporto al plafone Acciaio inossidabile, può essere accorciato sul luogo

NOSAG	SGVSB Team	Sanitas Troesch	A	B	C
LDA.1808.525*	171 560	4721 897	800		
LDA.1810.525*	171 557		1000		
LDA.1815.525*			1500		
LDA.1808.583**	171 560	4721 897	800		
LDA.1810.583**	171 557		1000		
LDA.1815.583**			1500		

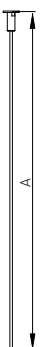



Duschspritzschutz Edelstahl, mit Fallsicherung, Wandmontage, vorderer Bogen schwenkbar

Pare-éclaboussures Acier inoxydable, peut être raccourci par le client

Protezione antischizzo Acciaio inossidabile, con freno di sicurezza, montaggio a muro, curva anteriore girevole

Max. 80 kg

NOSAG	SGVSB Team	Sanitas Troesch	A	B	C
FD6.1294.525.L*			880	440	
FD6.1294.525.R*			880	440	
FD6.1294.583.L**			880	440	
FD6.1294.583.R**			880	440	

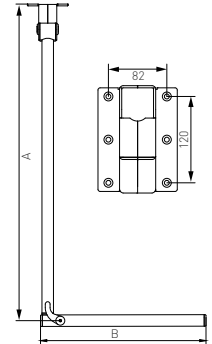

Montagesets | Sets de montage | Set di montaggio

für pour per	NOSAG	SGVSB Team	Sanitas Troesch
Lochziegelsteine brique mattone forato	LM1.0100.000	585 396	4721 387
Leichtbauwand paroi légèr parete divisoria leggera	LM1.0200.000	585 397	4721 388
Beton béton calcestruzzo	LM1.0300.000	585 395	



Duschspritzschutzvorhang 100% Polyesterstoff, mit Bleiband, bei 40° waschbar, Relief white, mit Klettschlaufen

Rideau pare-éclaboussures 100% polyester étoffes, avec ourlet, plombé, lavable à 40°, Relief white, avec boucles velcro

Tenda paraspruzzi 100% poliestere, bordo con piombo, lavabile a 40°, Relief white, passante con velcro

NOSAG	SGVSB Team	Sanitas Troesch	A	B	C
FDA.0799.100			1350	850	

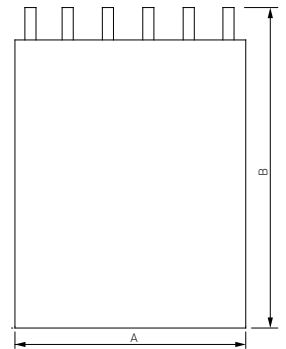

Duschspritzschutz Edelstahl, mit Fallsicherung, für Wandmontage, **MIT Montageplatte**

Pare-éclaboussures Acier inoxydable, avec frein de sécurité, montage mural, **AVEC plaque de montage**

Protezione antiscivolo Acciaio inossidabile, con freno di sicurezza, montaggio a muro, **CON placca di montaggio**

Max. 120 kg

NOSAG	SGVSB Team	Sanitas Troesch	A	B	C
LD6.0008.525*			850	250	110
LD6.0008.583**			850	250	110

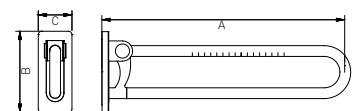

Montagesets | Sets de montage | Set di montaggio



für pour per	NOSAG	SGVSB Team	Sanitas Troesch
Lochziegelsteine brique mattone forato	LM1.0100.000	585 390	4721 387
Leichtbauwand paroi léger parete divisoria leggera	LM1.0200.000	585 391	4721 388
Beton béton calcestruzzo	LM1.0300.000	585 392	



Spritzschutzvorhang 100% Polyester, mit Bleiband, bei 60° waschbar, weiss mit Struktur, mit Klettverschluss

Rideau pour pare-éclaboussures Polyester 100%, blanc, avec ourlet plombé, lavable à 60°, blanc avec structur, avec boucles velcro

Tenda antischizzo 100% poliestere, bordo con piombo, lavabile a 60°, bianco con struttura, passante con velcro

NOSAG	SGVSB Team	Sanitas Troesch	A	B	C
NDA.0761.019			700	615	

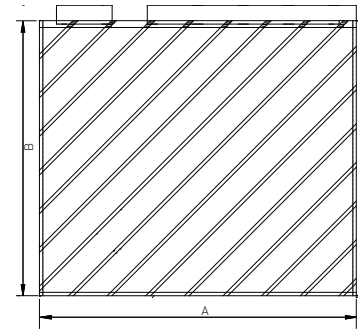

Duschspritzschutz mobil Edelstahl

Pare éclaboussure mobile Acier inoxydable

Protezione antischizzo mobile Acciaio inossidabile

NOSAG	SGVSB Team	Sanitas Troesch	A	B	C
LD6.1500.525*	585 013	4721 887	440	735	950
LD6.1500.583**	585 013		440	735	950

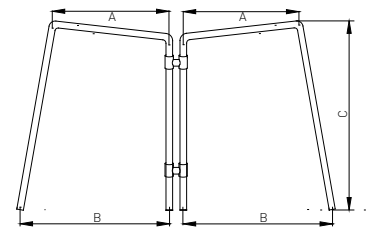



Wandhaken Edelstahl

Crochet mural Acier inoxydable

Gancio portasciugamani Acciaio inossidabile

NOSAG	SGVSB Team	Sanitas Troesch	A	B	C
LLA.1711.525*			65	54	25
LLA.1711.583**			65	54	25

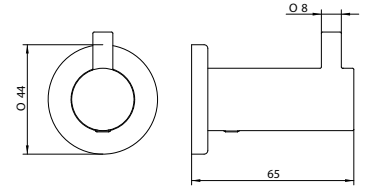

Doppelhaken Edelstahl

Crochet double Acier inoxydable

Gancio doppio Acciaio inossidabile

NOSAG	SGVSB Team	Sanitas Troesch	A	B	C
LLA.1712.525*			65	54	25
LLA.1712.583**			65	54	25

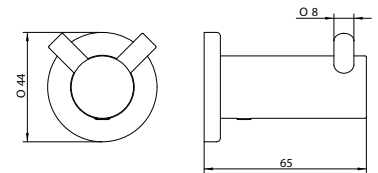

Haltegriff mit Handtuchhalter Edelstahl

Barre d'appui avec porte-serviette Acier inoxydable

Corrimano con portasalviette Acciaio inossidabile

Max. 150 kg

NOSAG	SGVSB Team	Sanitas Troesch	A	B	C
LLA.0630.525*	585 018	4721 810	600	45	80
LLA.0631.525*	585 019	4721 812	800	45	80
LLA.0630.583**	585 018	4721 810	600	45	80
LLA.0631.583**	585 019	4721 812	800	45	80

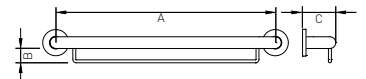

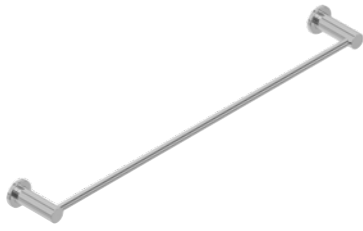

Handtuchhalter Edelstahl
Porte-serviette Acier inoxydable
Portaserviette Acciaio inossidabile

NOSAG	SGVSB Team	Sanitas Troesch	A	B	C
LLA.1616.525*			600	80	
LLA.1616.583**			600	80	

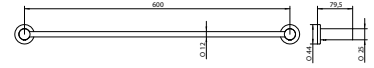

Glashalter Edelstahl, mit Glas
Porte-verre Acier inoxydable, avec verre
Portabicchiere Acciaio inossidabile, bicchiere in vetro

NOSAG	SGVSB Team	Sanitas Troesch	A	B	C
LLA.1111.525*			97	106	66
LLA.1111.583**			97	106	66

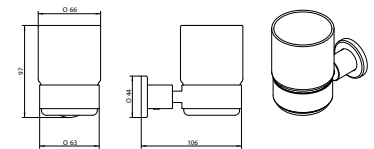

Doppelglashalter Edelstahl, mit Glas
Porte-verre Acier inoxydable, avec verre
Portabicchiere doppio Acciaio inossidabile, bicchiere in vetro

NOSAG	SGVSB Team	Sanitas Troesch	A	B	C
LLA.1112.525*			95	173	86
LLA.1112.583**			95	173	86

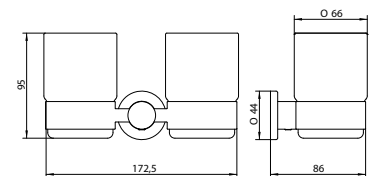



Seifenablage
Porte-savon
Portasapone

NOSAG	SGVSB Team	Sanitas Troesch	A	B	C
LLA.1311.525*			54	128	108
LLA.1311.583**			54	128	108

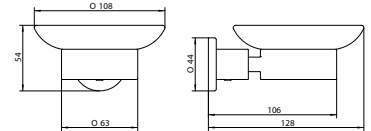

Wandseifenspender BALI LUX Edelstahl, Wandmontage, für 700 ml Schaumseife BALI PLUS /
Desinfizierende Schaumseife BALI DISINFECTING

Distributeur de savon mural BALI LUX Acier inoxydable, montage mural, pour 700 ml savon en mousse
BALI PLUS / Savon en mousse désinfectant BALI DISINFECTING

Distributore di sapone BALI LUX Acciaio inossidabile, montaggio a muro, per 700 ml sapone schiuma
BALI PLUS / Sapone schiuma disinfettante BALI DISINFECTING

NOSAG	SGVSB Team	Sanitas Troesch	A	B	C
MLA.1307.525*	585 050	4721 105	260	104	102
MLA.1307.583**	585 050		260	104	102

Dazugehöriger Artikel | Article correspondant | Articoli correlati

Schaumseife BALI PLUS

Savon en mousse BALI PLUS

Sapone schiuma BALI PLUS

MLV.M12P.000

Desinfektionsmittel BALI DISINFECTING

désinfectant BALI DISINFECTING

disinfettante BALI DISINFECTING

MLV.M14P.000

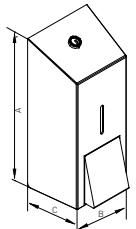

Wandseifenspender MAXI Edelstahl, Wandmontage, für 880 ml handelsübliche Flüssigseife oder
Desinfektionsmittel

Distributeur de savon mural MAXI Acier inoxydable, montage mural, convient pour 800 ml de savon
liquide commercial ou de désinfectant

Distributore di sapone MAXI Acciaio inossidabile, montaggio a muro, per 800 ml sapone liquido e
disinfettante d'uso commerciale

NOSAG	SGVSB Team	Sanitas Troesch	A	B	C
MLA.1318.525*	585 051		260	120	110
MLA.1318.583**	585 051		260	120	110

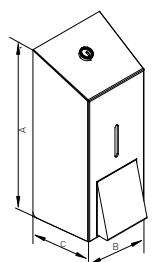



Papierhandtuchspender MINI Edelstahl, Wandmontage, für 250 Blätter, für Z-Falz

Distributer de serviettes en papier MINI Acier inoxydable, montage mural, pour 250 serviettes, pour plié Z

Distributore d'asciugamani MINI Acciaio inossidabile, montaggio a muro, per 250 foglie, per piegatura a Z

NOSAG	SGVSB Team	Sanitas Troesch	A	B	C
MLA.1202.525*	585 052		155	255	120
MLA.1202.583**	585 052		155	255	120

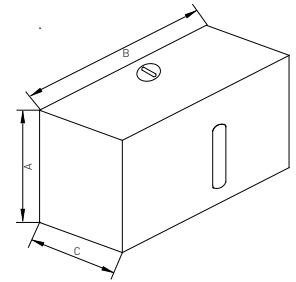

Papierhandtuchspender MAXI Edelstahl, Wandmontage, für 500 Blätter, für C/Z-Falz

Distributer de serviettes en papier MAXI Acier inoxydable, montage mural, pour 500 serviettes, pour plié C/Z

Distributore d'asciugamani MAXI Acciaio inossidabile, montaggio a muro, per 500 foglie, per piegatura a C/Z

NOSAG	SGVSB Team	Sanitas Troesch	A	B	C
MLA.1205.525*	585 053	4721 110	265	255	120
MLA.1205.583**	585 053		265	255	120

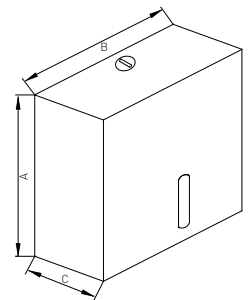



Abfallbehälter Edelstahl, Wandmontage, 27 Liter

Poubelle Acier inoxydable, montage mural, 27 litre

Contentore rifiuti Acciaio inossidabile, montaggio a muro, 27 litri

NOSAG	SGVSB Team	Sanitas Troesch	A	B	C
MLA.1402.525*	585 054	4721109	595	340	165
MLA.1402.583**	585 054		595	340	165

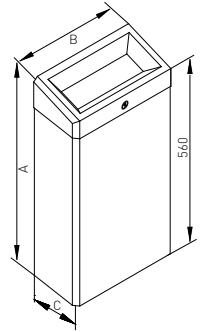

Abfallbehälter Edelstahl, Wandmontage, 45 Liter

Poubelle Acier inoxydable, montage mural, 45 litre

Contentore rifiuti Acciaio inossidabile, montaggio a muro, 45 litri

NOSAG	SGVSB Team	Sanitas Troesch	A	B	C
MLA.1404.525*	585 055		624	336	254
MLA.1404.583*	585 055		624	336	254

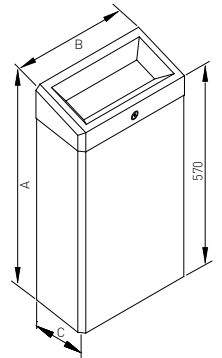

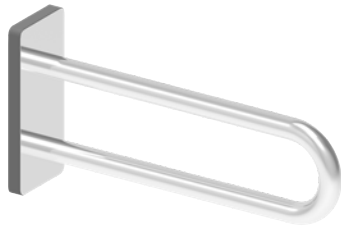
**Stützgriff** Edelstahl, **MIT Montageplatte****Barre d'appui** Acier inoxydable, **AVEC plaque de montage****Impugnatura di supporto** Acciaio inossidabile, **CON placca di montaggio****Max. 120 kg**

NOSAG	SGVSB Team	Sanitas Troesch	A	B	C
LL0.0006.525*			600	250	110
LL0.0006.583**			600	250	110

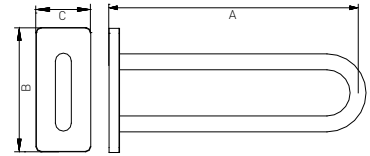
**Montagesets** | Sets de montage | Set di montaggio

für pour per	NOSAG	SGVSB Team	Sanitas Troesch
Lochziegelsteine brique mattone forato	LM1.0100.000	585 390	4721 387
Leichtbauwand paroi léger parete divisoria leggera	LM1.0200.000	585 391	4721 388
Beton béton calcestruzzo	LM1.0300.000	585 392	

**Winkelgriff** Edelstahl, 135°**Poignée latérale** Acier inoxydable, 135°**Corrimano ad angolo** Acciaio inossidabile, 135°**Max. 120 kg**

NOSAG	SGVSB Team	Sanitas Troesch	A	B	C
LB1.0035.525.L*			300	500	80
LB1.0035.525.R*			300	500	80
LB1.0035.583.L**			300	500	80
LB1.0035.583.R**			300	500	80

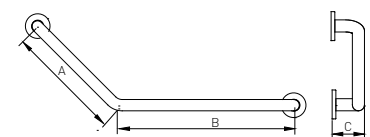
Abbildung in linkser Ausführung (L)
Illustration en version gauche (L)
Illustrazione in versione sinistra (L)